



T&S BRASS AND BRONZE WORKS, INC.

2 Saddleback Cove / P.O. Box 1088
Travelers Rest, SC 29690

Model No.

BL-5700-01

Item No.

Travelers Rest, SC: 800-476-4103 • Simi Valley, CA: 800-423-0150 • Fax: 864-834-3518 • www.tsbrass.com

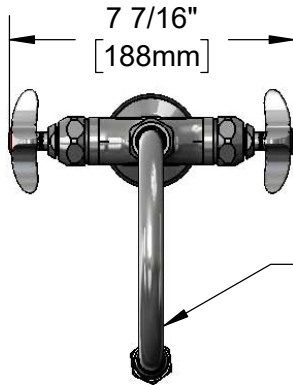

ADA Compliant

Swivel Gooseneck w/
B-0198
Serrated Tip & Washer.
Converts to Rigid w/
014200-45 Lock Washer
(Included).

This Space for Architect/Engineer Approval

Job Name _____ Date _____

Model Specified _____ Quantity _____

Customer/Wholesaler _____

Contractor _____

Architect/Engineer _____

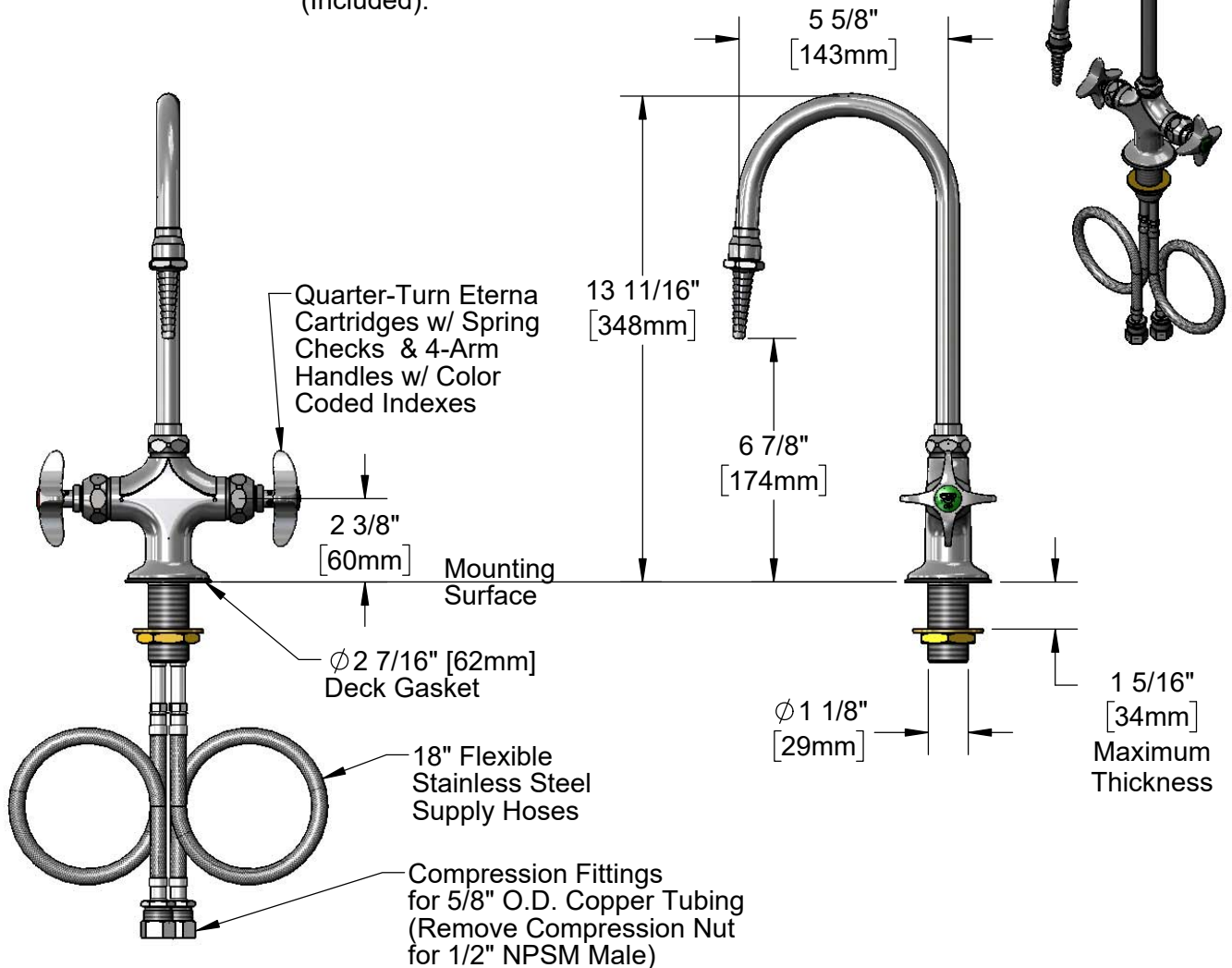

Rough-In Requirement:
Ø 1 1/2" [38mm] Mounting Hole

Product Specifications:

Single Hole Deck Mount Mixing Faucet, Quarter-Turn Eterna Cartridges w/ Spring Checks, 4-Arm Handles, Swivel/Rigid Gooseneck w/ Serrated Tip Outlet & 18" Flexible Stainless Steel Supply Hoses w/ 1/2" NPSM Male Inlets

Product Compliance:

ASME A112.18.1 / CSA B125.1
NSF 61 - Section 9
NSF 372 (Low Lead Content)
ANSI A117.1 (ADA)



T&S BRASS AND BRONZE WORKS, INC.
 2 Saddleback Cove / P.O. Box 1088
 Travelers Rest, SC 29690

Model No.
BL-5700-01

Item No.

Travelers Rest, SC: 800-476-4103 • Simi Valley, CA: 800-423-0150 • Fax: 864-834-3518 • www.tsbrass.com

ITEM NO.	SALES NO.	DESCRIPTION
1	B-0198	Serrated Tip w/ Washer
2	001051-45	Washer
3	009538-45	Swivel Washer
4	011429-45	Swivel Sleeves (2)
5	001074-45	O-Ring
6	014200-45	Star Washer, Anti-Rotation
7	012443-40NS	Quarter-Turn Eterna Cartridge w/ Spring Check, RTC
8	000925-45	Lab Handle Screw
9	001191-45NS	Green "CW" Lab Button Index
10	145L	Black Plastic Gasket
11	002290-45	Lock Washer
12	000965-45	Lock Nut
13	012534-45	18" Flexible Supply Hose (2)
14	002521-45NS	4-Arm Handle (New Style)
15	001194-45NS	Red "HW" Lab Button Index

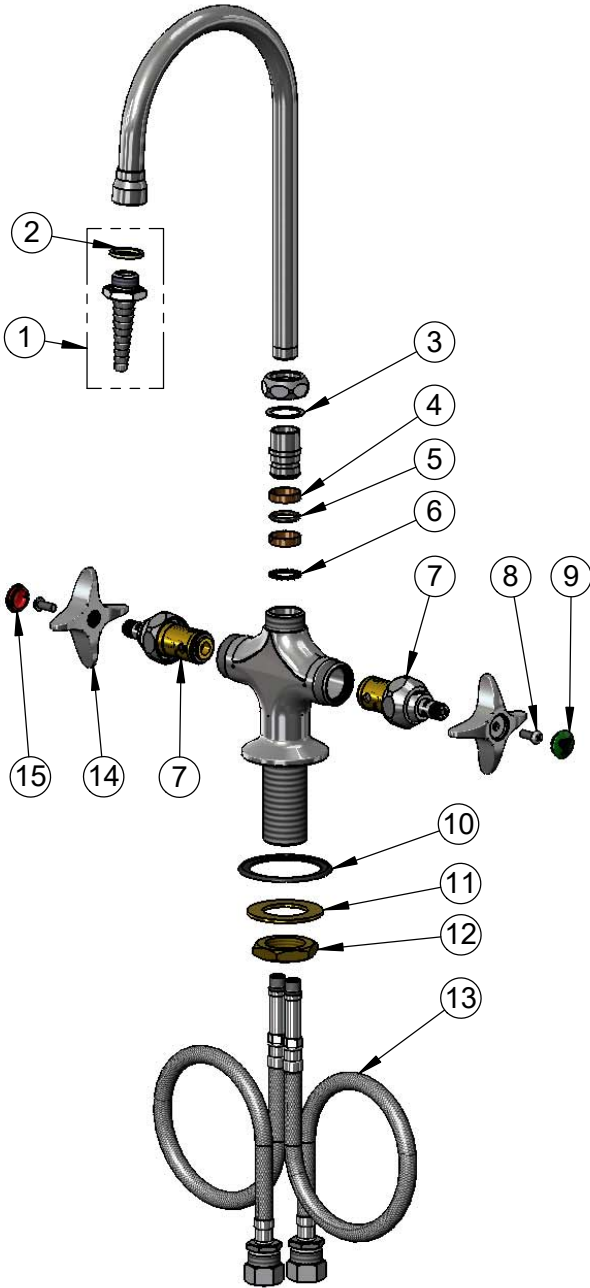

Product Specifications:

Single Hole Deck Mount Mixing Faucet, Quarter-Turn Eterna Cartridges w/ Spring Checks, 4-Arm Handles, Swivel/Rigid Gooseneck w/ Serrated Tip Outlet & 18" Flexible Stainless Steel Supply Hoses w/ 1/2" NPSM Male Inlets

Product Compliance:

ASME A112.18.1 / CSA B125.1
 NSF 61 - Section 9
 NSF 372 (Low Lead Content)
 ANSI A117.1 (ADA)