



ASSEMBLY AND INSTALLATION

INSTRUCTION

Please read carefully and save this instruction, as you may need them at a later date.

CAUTION

Turn off the main power at the circuit breaker before installing the fixture, in order to prevent possible shock. If you are unfamiliar with proper electrical wiring connections, please consult of a qualified electrician before installing

Installing Step:

Remove the fixture and the mounting package from the box and make sure that no parts missing in the box.

1. Use Screw (2) to thread the Back Plate (1) onto the wall tightly.
2. Put Glass(4) onto Socket(3) , then thread Socket ring(5) onto them tightly.
3. Install bulbs: (Bulbs not including in the package)
(Please don't exceed the maximum capacity that recommended on the Sockets)

INSTALLATION IS NOW COMPLETED.

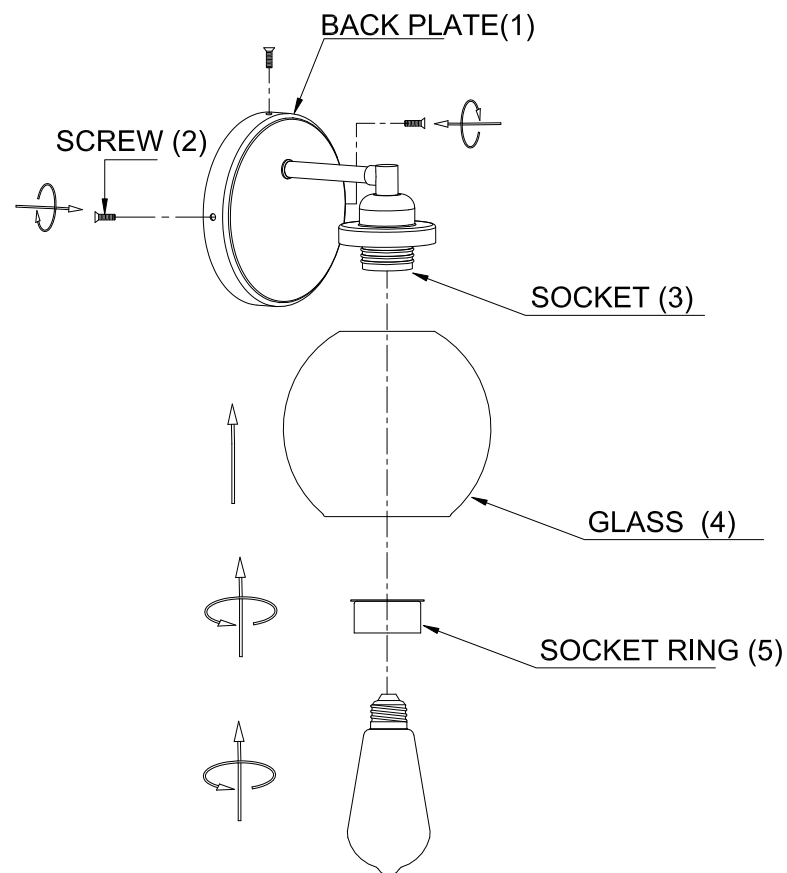

9-4050-1-SN
9-4050-1-322
9-4050-1-BK