

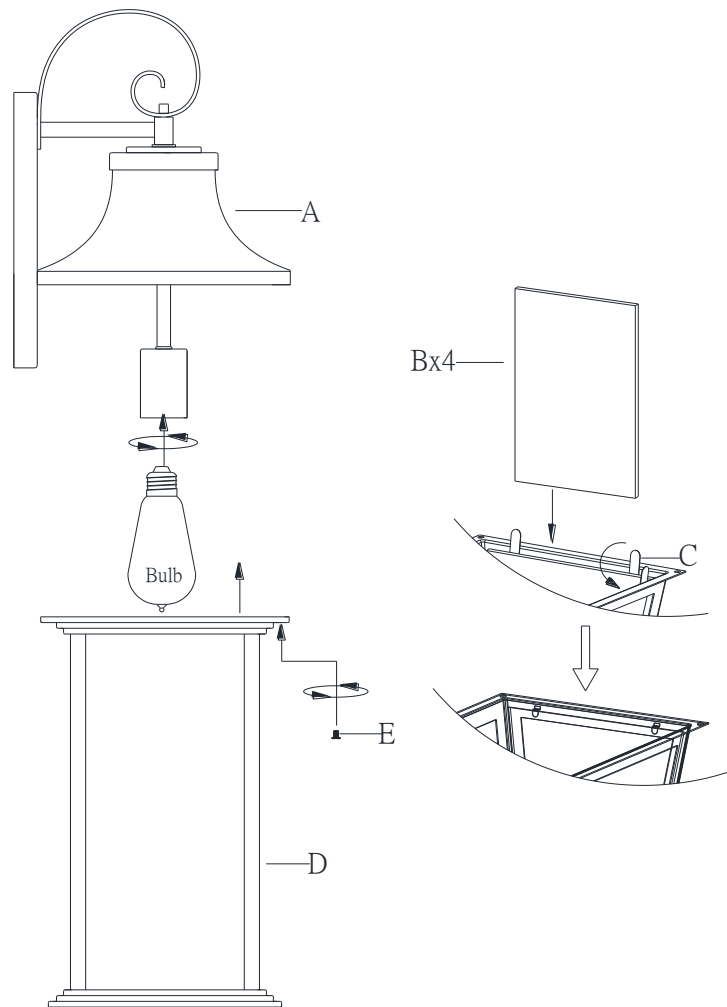

## ASSEMBLY INSTRUCTIONS

ITEM NO.: 5-451-BK



Bulb → A → B → C → D → E

1. Carefully unpack and identify all parts referring to illustration for parts identification.
2. Turn the power to the installation point OFF.
3. Referring to the installation instruction with the product for the wiring and installation.
4. Install proper bulb (not provided) to the sockets referring to the marking and/or labels on the fixture for maximum wattage.
5. Carefully place glass panel (B) to the frame (D), fixing with clip (C) of the frame (D) as shown in the diagram.
6. Carefully place frame (D) to the fixture body (A), securing with screws (E).
7. Restore the power to the installation point ON.
8. Assembly is completely. Retain this sheet for future reference.
9. If you want to replace BULB, please first turn OFF the power, then unscrew the screws (E), remove the frame (D), then carefully replace bulb with hands.