

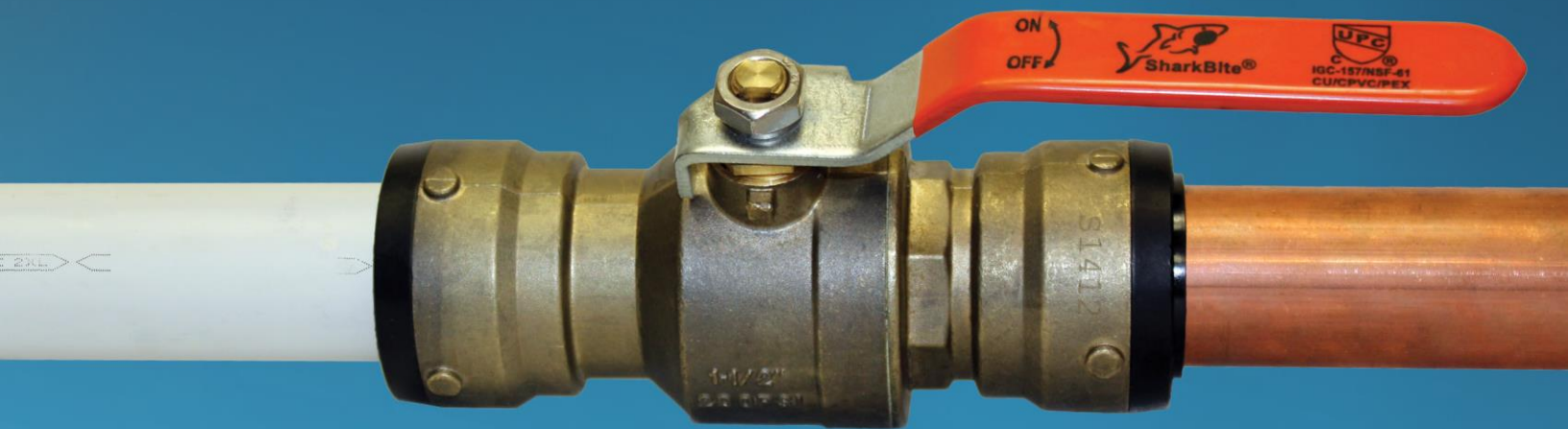

# SHARKBITE® PUSH-FIT CONNECTION SYSTEM



**Push To Connect Fittings for Copper, PEX and CPVC**  
**Specification Submittal Package for Potable Water**  
**and Hydronic Heating**

[www.sharkbite.com](http://www.sharkbite.com)



## Table of Contents

SYSTEM DATA SHEET .....	3
ENGINEERING SPECIFICATIONS .....	4
THE SHARKBITE DESIGN (1/4" – 1").....	7
WHY SHARKBITE? .....	7
CONNECTING A SHARKBITE FITTING.....	8
DISCONNECTING A FITTING.....	9
SHARKBITE SLIP PRODUCTS .....	9
SHARKBITE SLIP PRODUCTS .....	10
SHARKBITE FOR CONCEALED AREAS.....	11
DIMENSIONS .....	11
PRESSURE LOSS AND FLOW RATES .....	13
ASSE 1061 TESTING.....	15
THE SHARKBITE 2XL DESIGN (1-1/4" – 2") .....	18
WHY SHARKBITE 2XL? .....	19
HOW TO MAKE A SHARKBITE 2XL CONNECTION .....	20
DISCONNECTING A SHARKBITE 2XL CONNECTION .....	21
SHARKBITE 2XL DIMENSIONS.....	22
SHARKBITE 2XL PRESSURE LOSS AND FLOW RATES.....	23
SHARKBITE PEX TUBING.....	25
PEX PIPE SPECS AND DIMENSIONS .....	27
PROJECT PROFILE.....	29
PROJECT PROFILE.....	30
IAPMO RESEARCH AND TESTING, INC.....	31
WARRANTY .....	36



## SYSTEM DATA SHEET

### System Description

The SharkBite Push-Fit quick-connect plumbing system is the easiest and most dependable way to join copper, CPVC or PEX pipe in any combination—with no soldering, clamps, unions or glue. Available in an assortment of over 200 fittings and sizes ranging from 1/4" to 2" copper tube size (CTS).

### Applications

Tubing: Hard drawn copper pipe Type K, L and M and annealed Type M not to exceed 3/8 nominal complying with ASTM B 88, PEX tubing complying with ASTM F 876 or CSA B137.5, or CVPC tubing complying with ASTM D 2846 or CSA B137.6. SharkBite fittings are approved for installations above and below ground applications. Please consult with local code for final approval. Failure to comply with the above types of pipe or application could result in connection failures.

### Operating Parameters

Operating Pressure: 200 PSI Max  
Operating Temperature: 200°F Max

### Approved Applications

- Potable Water
- Hydronic Heating (w/ Glycol concentration up to 100%)

### System Benefits

- Instant push-fit connection for increased ease of use
- No soldering, clamps, unions or glue needed
- Reduces installation time with no tightening of nuts, clamps and unions.
- Connects three types of pipe in any combination
- No mapping of system
- Can be installed wet or dry
- Rotatable after installation
- Approved for behind the wall and underground applications.
- Removable after installation
- Clean, professional installation

### Fittings

SharkBite push-fit fittings are available in 200+ configurations including: Couplings, Elbows, Tees, Reducers, Threaded Adapters, Caps, Stops, Stub Outs, Ball Valves, Slips, Water Heater Hoses and Valves with SharkBite Connections. Made from Lead Free Dezincification Resistant (DZR) brass and available in sizes 1/4" – 2" CTS.

### Push-to-Connect Technology

The SharkBite fitting works via a two stage process that ensures a quick, easy connection.

- The tubing passes through the release collar and then through the stainless steel grab ring.
- The tube is pushed through an o-ring protector that aligns the tube. It then passes through a specially formulated o-ring that compresses between the pipe and the wall of the fitting before it reaches the tube stop.

### How to Make a Connection

1. Cut the pipe. Make sure the cut is square and even.
2. Deburr the end of the pipe to remove any sharp edges. Sharp edges can cut the o-ring and lead to leaks.
3. Mark the pipe with the proper insertion depth (see below for reference).
4. Push the pipe into the fitting. The mark made on the pipe should rest against the collar of the fitting, ensuring a proper seal.

FITTING SIZE	INSERTION DEPTH
1/4"	0.813"
3/8"	0.875"
1/2"	0.938"
5/8"	1.125"
3/4"	1.125"
1"	1.313"
1-1/4"	2.000"
1-1/2"	2.250"
2"	2.500"

### Tube Liner

SharkBite fittings ranging in sizes 3/8" to 1" come with an integral tube liner preinstalled for use with PEX pipe. SharkBite sizes 1-1/4" to 2" do not come with tube liners preinstalled and are sold separately. The tube liner must be used when PEX piping is utilized.

### Tools

Tools are available to make the installation process easier.

- SharkBite depth & deburring tool for 1/4" to 1" CTS
- SharkBite depth & deburring tool for 1-1/4" to 2" CTS
- SharkBite disconnect clip (1 size per tubing)
- SharkBite disconnect tongs (1 size per tubing)

### History

SharkBite was launched in the Australian market in 1999 and in the North America market in 2004, ushering in a new way to do plumbing. Reliance Worldwide, an ISO 9001 organization, is one of the world's largest manufacturers of thermostatic water control valves and has been a major world supplier of hot water safety valves for over 50 years.

### Warranty

SharkBite fittings carry a 25 year warranty against any manufacturer's defect as long as the item has been installed per installation instructions and comply with local code. Please contact Customer Service for more information.

### IAPMO

<http://pld.iapmo.org/default.asp>

(Select Listee Name and enter "Reliance Worldwide")

### For more information on SharkBite products, contact:

Reliance Worldwide Corporation  
2727 Paces Ferry Road  
Building 2, Suite 1800  
Atlanta, GA 30339  
United States: 1-877-700-4242  
Canada: 1-888-820-0120  
Web: [www.sharkbite.com](http://www.sharkbite.com)



## ENGINEERING SPECIFICATIONS

The push-fit fitting shall be installed on hard drawn copper type K, L and M complying with ASTM B88, cross-linked polyethylene pipe (PEX) complying with ASTM F 876 or CSA B137.5 or CPVC piping complying with ASTM D 2846 or CSA B137.6. The fitting shall be made of lead free dezincification brass and compliant with ASSE 1061, NSF/ANSI 61 and NSF/ANSI 372. The fitting shall consist of an EPDM O-ring, a grade 316 stainless steel grab ring, and contain a polysulfone tube liner for PEX applications. The fitting shall be used in a potable water system or a hydronic heating water distribution up to 200 psi and 200°F. The fitting shall be a SharkBite fitting.

### PART 1: GENERAL

#### 1.1 SUMMARY

- A. Push-Fit Connection System for Potable Water Distribution and Hydronic Heating Water Distribution

#### 1.2 DEFINITIONS

- A. ASME: American Society of Mechanical Engineers
- B. ASSE: American Society of Safety Engineers
- C. ASTM: American Society for Testing and Materials
- D. CSA: Canadian Standards Association
- E. EPDM: Ethylene Propylene Diene Monomer
- F. IAPMO: International Association of Plumbing and Mechanical Officials
- G. NSF: National Sanitation Foundation

#### 1.3 REFERENCES

- A. ASSE 1061: Performance Requirements for Push-Fit Fittings
- B. NSF/ANSI Standard 61: Certification for Drinking Water System Components – Health Effects
- C. NSF/ANSI Standard 14: Plastics Piping System Components and Related Materials
- D. NSF/ANSI Standard 372: Lead Content Certification
- E. ASTM B 88: Standard Specifications for Seamless Copper Water Tube
- F. ASTM F 876: Standard Specification for Cross-linked Polyethylene (PEX) Tubing
- G. CSA B137.5: Cross-linked Polyethylene (PEX) Tubing Systems for Pressure Applications
- H. CSA B137.6
- I. ASTM D 2846: Standard Specification for Chlorinated Poly(Vinyl Chloride) (CPVC) Plastic Hot-and Cold-Water Distribution Systems.
- J. IAPMO: Uniform Plumbing Code
- K. IAPMO: National Plumbing Code of Canada
- L. IAPMO: International Plumbing Code
- M. AWWA C904: Cross-Linked Polyethylene (PEX) Pressure Pipe, ½ In. (12mm) Through 3 In. (.76 mm) for Water Service.

#### 1.4 QUALITY ASSURANCE

- A. Installer shall be well informed on installation instructions prior to installing.
- B. The installation of tubing and fittings for hot and cold water distribution systems shall conform to the requirements of the ICC International Plumbing Code or IAPMO Uniform Plumbing Code.
- C. The piping shall be cut square, even and have no rough edges.



## 1.5 WARRANTY

- A. SharkBite Push-Fit Fittings have a 25 year limited warranty from point of sale.
- B. All products must be installed in accordance with all applicable codes and in accordance with any local, state, provincial or federal requirements.
- C. The installing contractor must use construction techniques compliant with applicable codes to install the range of products and use the product(s) within the design parameters specified in any installation guidelines and technical notes for the applicable system. This shall include field pressure testing prior to concealing with concrete or by other means.
- D. Products must not be installed in a system that may operate at temperatures or at pressures that exceed the printed rating on the product, packaging or installation instructions.
- E. Evidence of tampering, mishandling, neglect, accidental damage, freeze damage or unauthorized modifications or repairs that cause damage to RWC warranted products void any warranty coverage of those particular products. It is expressly understood that failure as a result of any freezing fluids within the pipes does not constitute a defect in material or workmanship and shall not be covered by this warranty.
- F. Although RWC provides a plumbing system to facilitate a complete installation, other manufacturers tubing and/or fittings may be installed in any given installation provided manufacturing of the tubing and/or fittings demonstrates compliance with the applicable ASTM standards, and the product has been certified by a recognized third-party testing agency. The RWC product in the given installation will continue to be covered under this warranty. **NOTE:** RWC will be responsible only for proven defects in material or workmanship in RWC products. Problems in products manufactured by another company should be reported to that manufacturer.
- G. For full warranty information, please see page 30.

## PART 2: PRODUCTS

### 2.1 MANUFACTURERS

- A. RWC, 2727 Paces Ferry Road, Building 2, Suite 1800, Atlanta, GA 30339  
Telephone: 1-877-700-4242, Website: [www.sharkbite.com](http://www.sharkbite.com)

### 2.2 MATERIAL

- A. Tubing Standard: Copper tubing shall be hard drawn Type K, L, or M and annealed Type M copper complying with ASTM B 88.
- B. Tubing Standard: Cross-linked polyethylene pipe (PEX) shall conform to ASTM F 876 or CSA B137.5.
- C. Tubing Standard: CPVC tubing shall conform to ASTM D 2846 or CSA B137.6.
- D. O-ring shall be made from EPDM.
- E. Grab ring shall be made from Grade 316 Stainless Steel.
- F. Push-fitting: Brass fitting shall comply with ASSE 1061 and NSF/ANSI 61.

### 2.3 SOURCE QUALITY

- A. All fittings in contact with drinking water shall be listed by a third party agency to NSF 61.



## PART 3: EXECUTION

### 3.1 EXAMINATION

- A. If installing PEX pipe, ensure that the tube liner has been installed.
- B. Ensure the fitting is free from any damage, including but not limited to damaged or missing O-ring, cracked brass forging or deformed grab ring.

### 3.2 PREPARATION

- A. The tubing shall be cut square to ensure a proper connection.
- B. The tubing shall be free of dirt, debris or scale buildup. Any burrs shall be removed using a deburring tool.
- C. Mark the piping to use as verification of proper insertion into the fitting.

### 3.3 INSTALLATION

- A. Push-fit fitting shall be installed in accordance with the manufacturer's installation instructions.
- B. Pressure Rating: Install components having a pressure rating equal to or less than the system operating pressure.
- C. Threaded Joints: Threaded joints shall have thread seal tape applied to the male threads only. Tighten joint with a wrench and backup wrench as required.
- D. Pipe Protection: Provide protection against abrasion where tubing/fitting is in contact with other building materials (including burial) by wrapping with an approved tape, pipe insulation or otherwise suitable method of isolation.
- E. Hydronic Heating: Glycol mixture for hydronic heating application is acceptable up to and including 100%.
- F. Behind the wall installation: Pressure test system for no less than 24 hours to ensure no leakage.
- G. Removal and reuse of push-fit fitting is allowed when executed in accordance with manufacturer's installation instructions.

### 3.4 FIELD QUALITY CONTROL

- A. Water Testing: The copper tubing system shall be water tested for joint tightness. The piping system shall be filled with water. The system shall be pressurized to the maximum pressure and length of time required by the code or standard. The system shall have no leaks at the rated pressure.

## THE SHARKBITE DESIGN (1/4" – 1")

The SharkBite Fitting incorporates a number of unique and patented features.

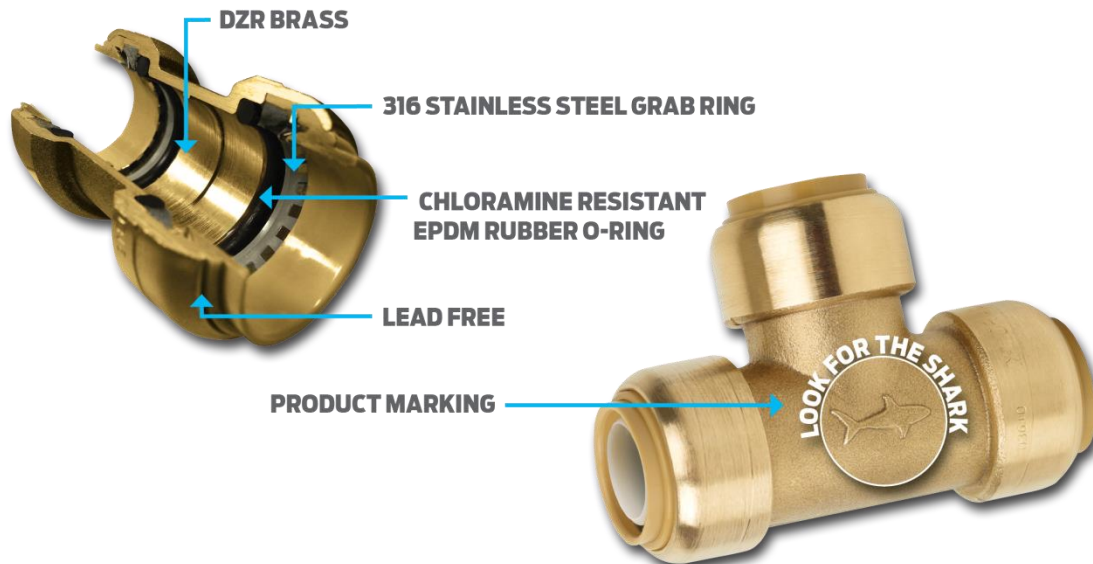

## WHY SHARKBITE?

- **Instant push-fit connection for increased ease-of-use:**
  - No soldering, clamps, unions, or glue required.
- **Fittings certified to 200 PSI and 200°F (93°C):**
  - Proven durability and quality.
- **Fits copper tubing, and CTS CPVC and PEX:**
  - Connects all three types in any combination.
- **Integral tube liner for PEX installations:**
  - Integrated design means no loose components, ensures secure, reliable connection.
- **Design certified and agency listed:**
  - Inspector friendly, peace of mind!
- **Compact, robust DZR brass body:**
  - Foundation of a strong, corrosion resistant, durable fitting.
- **Design certified to ANSI/NSF-61 and ASSE 1061 product standard for use in potable water and hydronic heating water distribution:**
  - Quality engineered and manufactured.
- **Approved to be used underground and behind walls without access panels.**
  - Designed for hydronic heating as well as potable water distribution.

## CONNECTING A SHARKBITE FITTING

1. Cut the desired length of pipe.
  - Make sure cuts are square and even.
  
2. Deburr the end of the pipe to remove any sharp edges.
  - This will ensure that the o-ring will not be damaged upon insertion of the pipe.
  
3. Using a depth gauge, mark the pipe.
  - A 1" mark on the pipe can be used as a guideline. Proper insertion depths are listed below.
  - This will let you know if your connection is successful.

Pipe Size	Insertion Depth
1/4"	0.813"
3/8"	0.875"
1/2"	0.938"
5/8"	1.125"
3/4"	1.125"
1"	1.313"

4. Push the pipe into the fitting.
  - The mark you made on the pipe should rest against the edge of the fitting.

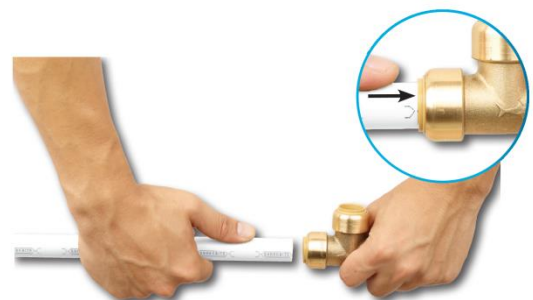



## DISCONNECTING A FITTING

### With the Disconnect Clip

1. Place the SharkBite disconnect clip around the tube with the non-branded side against the release collar.
2. Push the clip against the release collar and pull the tube with a twisting action to release the tube.



### With Disconnect Tongs

1. Place the teeth around the fitting assembly. The fork end with the SharkBite brand logo should be positioned around the tube and the other end around the neck of the fitting.
2. Squeeze the tool with one hand and pull the tube with a twisting action with the other hand to release the tube.



Check the fitting and tube end for damage. The fitting and tubing should be free of damage, foreign objects and marks on the outside diameter. If the tubing is damaged or marked, then cut and use a new section of tubing.



## SHARKBITE SLIP PRODUCTS

Slip fittings simplify repair by doing the job that two couplings and extra pipe would do. Only one end of the coupling has a stop, allowing the other end to slide freely over the end of a pipe. The fitting can be released with a disconnect tool and slid back onto the other end of the pipe for successful leak repair.



Cut out the section of the pipe needing repair (no more than 2" in length).

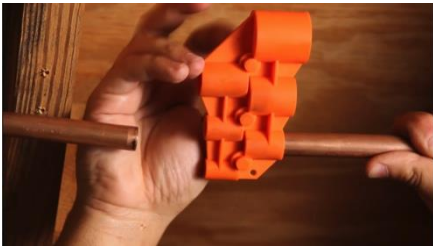

Using the SharkBite Deburring & Depth Gauge, clean the edges of the copper pipe. Use the gauge to mark the proper insertion depth on the pipe.



On the side of the fitting marked "SLIP END," slide the copper pipe into the fitting until it bottoms out.



Place the SharkBite Disconnect Clip on the copper pipe, on the same side as the "SLIP END." As you are pressing the clip to release the fitting, slide the SharkBite fitting to meet the other copper pipe.



Continue to slide the fitting until the non-slip end bottoms out. Ensure the fitting lines up with the mark you made. Also ensure the Slip End of the fitting has not proceeded past the depth mark you originally made.

## SHARKBITE SLIP PRODUCTS

In addition to slip coupling and tees, we also have slip ball valves and slip pressure regulators available to ease installation woes.



To see an installation video on installing a slip fitting, please visit:

<http://www.youtube.com/watch?v=lgdBv5BK5dQ&list=PL0ABAD0AF076CFA60&feature=c4-overview-vl>

## SHARKBITE FOR CONCEALED AREAS

SharkBite fittings can be utilized in underground applications and as manufactured joints without access panels, per IAPMO Certificate of Listing File No. 4630.

If burying SharkBite, it is recommended:

*Fitting should be wrapped with an impervious material, chloride-free tape or tightly wrapped and sealed insulation works well to prevent direct contact with the backfill. Backfill should be free of rocks, debris or any sharp objects that may cause damage through impact or abrasion.*

It is also recommended to pressure test the system for 24 hours before closing up any inaccessible location.

# SHARKBITE PUSH-FIT CONNECTION SYSTEM



## DIMENSIONS

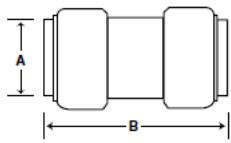

**Straight Coupling Dimensions**

P/N	A	B
U004	1/4"	1.59"
U006	3/8"	1.84"
U008	1/2"	2"
U016	3/4"	2.36"
U020	1"	2.72"

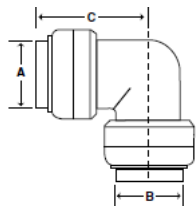

**Elbow Dimensions**

P/N	A	B	C
U244	1/4"	1/4"	1.16"
U276	1/4"	3/8" MIP	1.16"
U246	3/8"	3/8"	1.28"
U272	1/2"	3/8"	1.43"
U248	1/2"	1/2"	1.36"
U256	3/4"	3/4"	1.64"
U260	1"	1"	1.933"
U274	3/4"	1/2"	1.373"
U280	1/2"	1/2" MNPT	1.21"
U308	1/2"	1/2" FNPT	1.21"

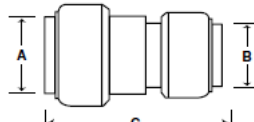

**Reducing Coupling Dimensions**

P/N	A	B	C
U009	3/8"	1/2"	2.0"
U058	3/4"	1/2"	2.2"
U060	1"	3/4"	2.51"

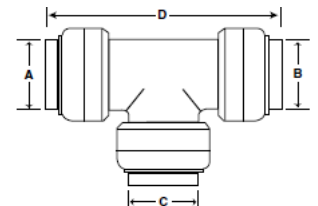

**Tee Dimensions**

P/N	A	B	C	D
U358	1/4"	1/4"	1/4"	2.30"
U360	3/8"	3/8"	3/8"	2.77"
U362	1/2"	1/2"	1/2"	2.72"
U363	1/2"	1/2"	3/8"	2.85"
U364	3/8"	3/8"	1/2"	2.77"
U370	3/4"	3/4"	3/4"	3.24"
U374	1"	1"	1"	3.84"
U412	3/4"	3/4"	1/2"	3.04"
U416	1"	1"	3/4"	3.63"
U444	3/4"	1/2"	3/4"	3.08"
U454	3/4"	1/2"	1/2"	2.92"

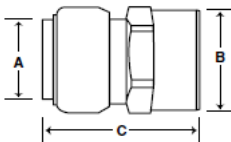

**Connector Dimensions**

P/N	A	B	C
U066	1/4"	1/2" FNPT	1.61"
U068	1/2"	3/4" FNPT	1.75"
U070	3/8"	1/2" FNPT	1.73"
U072	1/2"	1/2" FNPT	1.64"
U092	3/4"	1/2" FNPT	1.83"
U088	3/4"	3/4" FNPT	1.88"
U094	1"	1" FNPT	2.17"
U110	1/4"	1/2" MNPT	1.64"
U118	3/8"	1/2" MNPT	1.77"
U120	1/2"	1/2" MNPT	1.64"
U116	1/2"	3/4" MNPT	1.75"
U134	3/4"	3/4" MNPT	1.89"
U138	3/4"	1/2" MNPT	1.90"
U140	1"	1" MNPT	2.48"
U142	1"	3/4" MNPT	2.11"

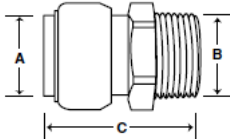

**Drop Ear Elbow Dimensions**

P/N	A	B	C
U249	1/2"	1/2"	2.20"
U332	3/8"	1/2" FNPT	1.83"
U334	1/2"	1/2" FNPT	1.77"
U335*	1/2"	1/2" FNPT	2.0"
U340	3/4"	3/4" FNPT	2.5"

\*Hy-Ear Elbow

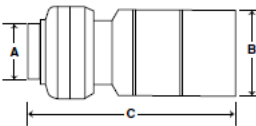

**Fitting Reducer Dimensions**

P/N	A	B	C
U719	3/8"	1/2"	2.08"
U721	3/8"	3/4"	2.27"
U722	1/2"	1"	3"
U724	3/4"	1"	2.5"

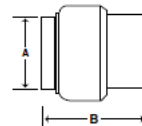

**End Stop Dimensions**

P/N	A	B
U512	3/8"	1.11"
U514	1/2"	1.08"
U518	3/4"	1.32"
U520	1"	1.52"

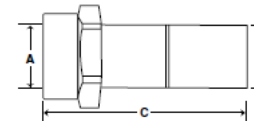

**Fitting Adapter Dimensions**

P/N	A	B	C
U766	3/4" FNPT	3/4"	2.83"
U772	1" FNPT	1"	2.83"

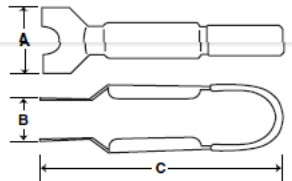

**Disconnect Tong Dimensions**

P/N	Fits SharkBite	A	B	C
U711	1/2"	1.7"	2"	6.5"
U713	3/4"	1.7"	2"	6.5"
U715	1"	1.7"	2"	6.5"

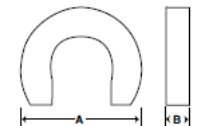

**Disconnect Clip Dimensions**

P/N	Size	A	B
U706	1/4"	1.19"	0.3"
U708	3/8"	1.22"	0.3"
U710	1/2"	1.22"	0.3"
U712	3/4"	1.72"	0.4"
U714	1"	2"	0.4"

Note: Disconnect Clips sold separately

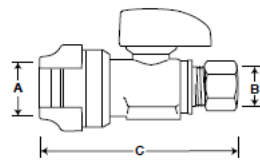

**Straight Stop (Chrome Plated) Dimensions**

P/N	A	B	C
23037-0000	1/2"	3/8" compression	2.68"

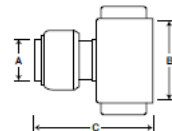

**Ballcock Connector Dimensions (Chrome Plated)**

P/N	A	B	C
U3531	1/4"	7/8" ballcock	1.58"

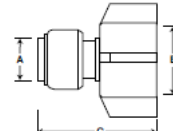

**Faucet Connector Dimensions (Chrome Plated)**

P/N	A	B	C
U3525	1/4"	1/2" NPS	1.58"

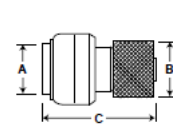

**Stop Connector Dimensions (Chrome Plated)**

P/N	A	B	C
U3523	1/4"	9/16" X 24 UNEF	1.61"

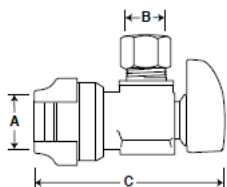

**Angle Stop (Chrome Plated) Dimensions**

P/N	A	B	C
23036-0000	1/2"	3/8" compression	2.58"

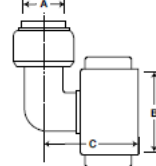

**Ballcock Elbow Dimensions (Chrome Plated)**

P/N	A	B	C
U3537	1/4"	7/8" ballcock	1.05"



## PRESSURE LOSS AND FLOW RATES

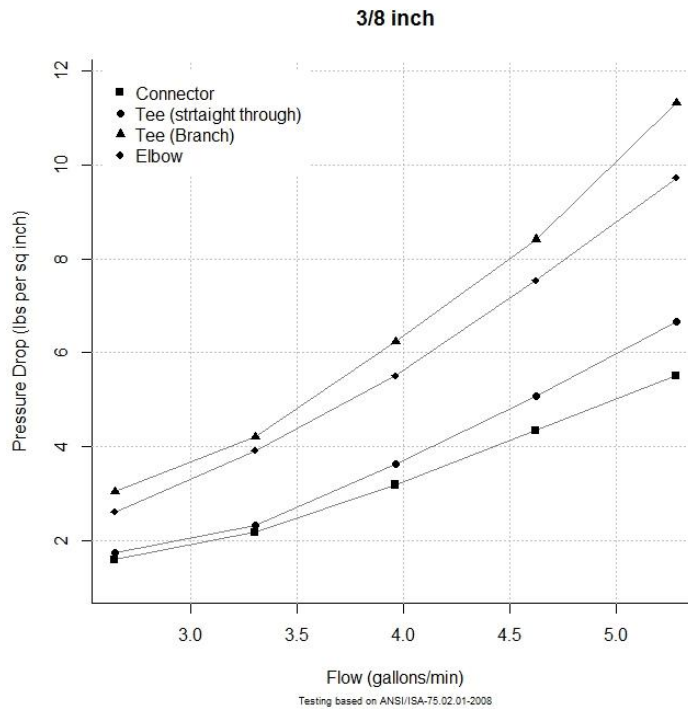
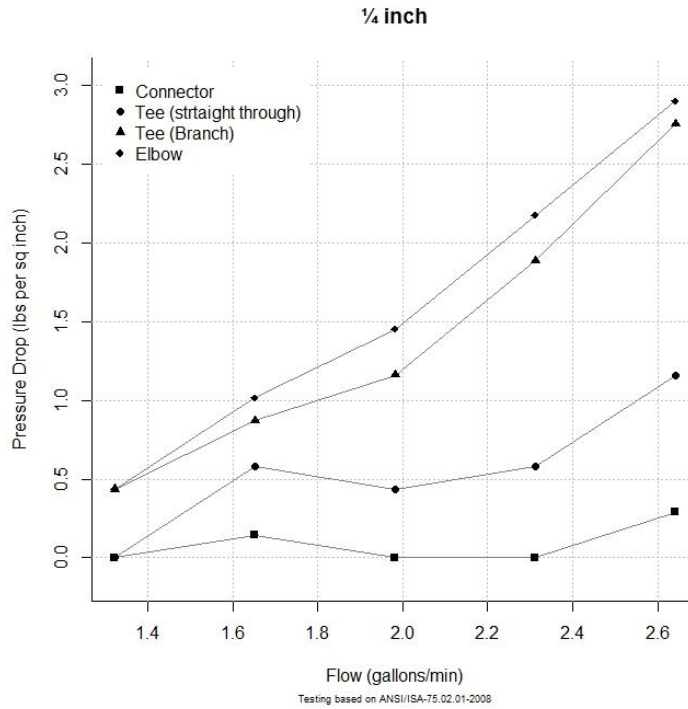

# SHARKBITE PUSH-FIT CONNECTION SYSTEM



## 1/2 inch

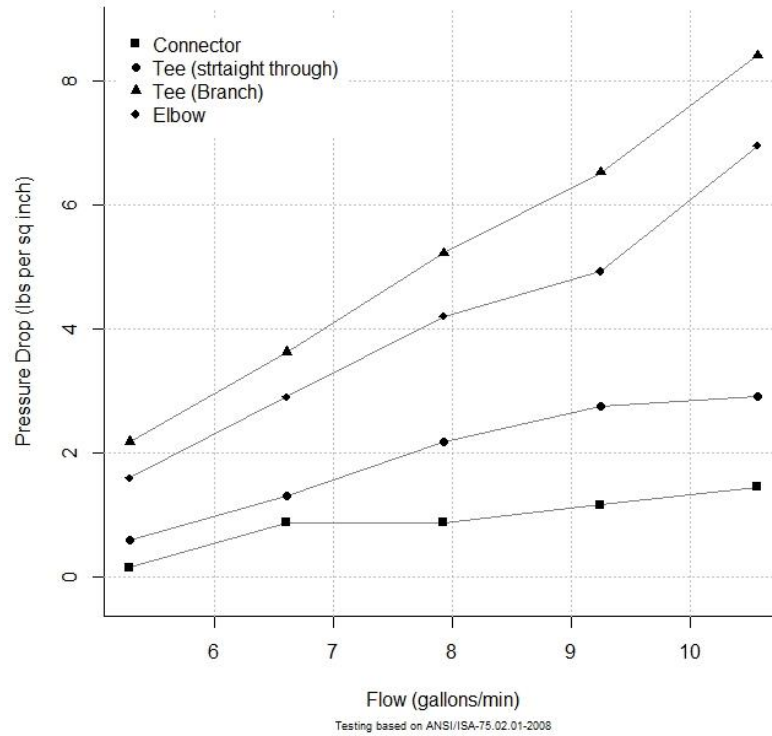

## 3/4 inch

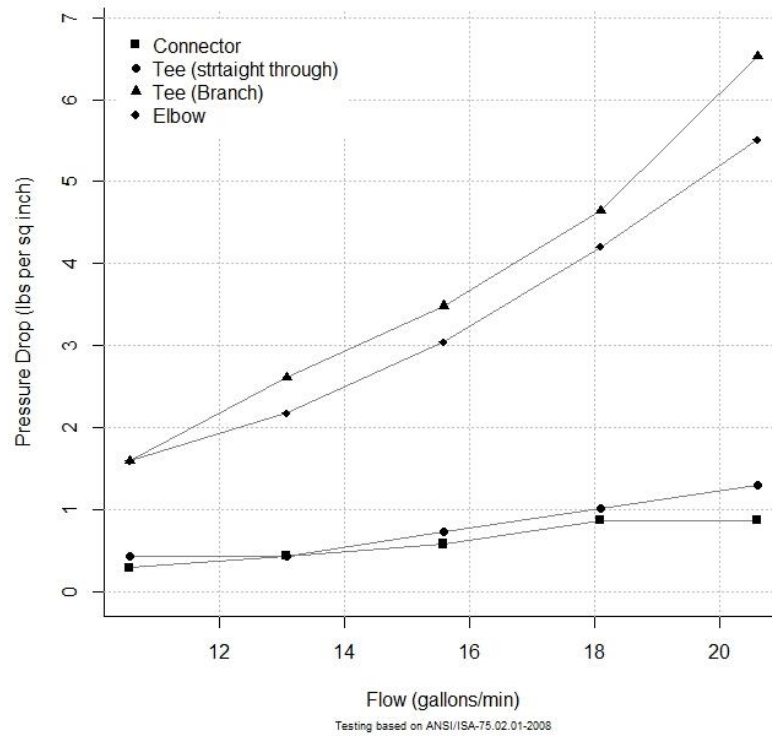

# SHARKBITE PUSH-FIT CONNECTION SYSTEM

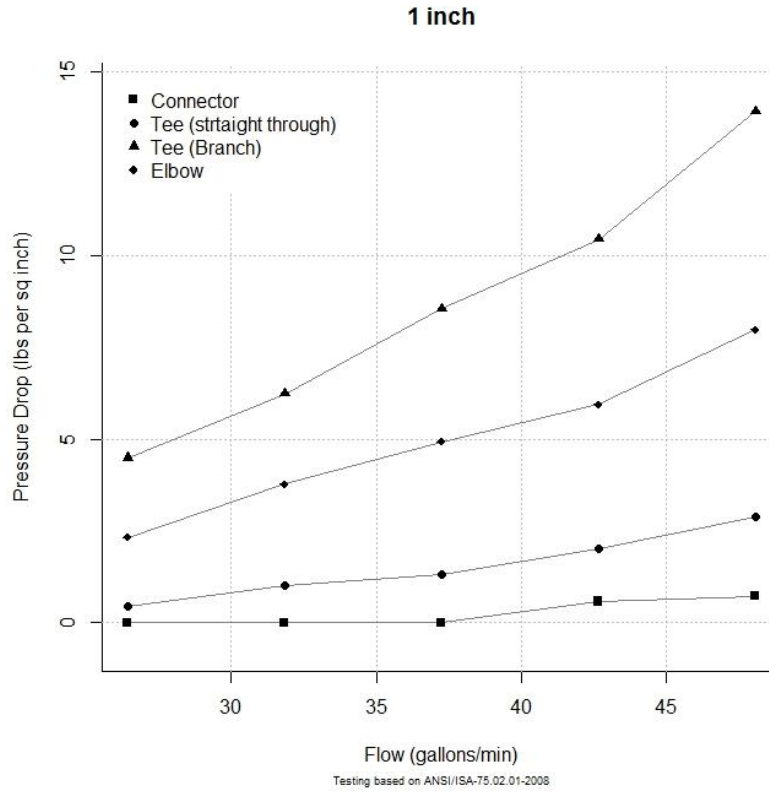



## ASSE 1061 TESTING

Below are some of the testing that SharkBite fittings

### Hydrostatic Burst:

Fittings and pipe assembled and raised to min burst pressures at temperatures below:

#### PEX

Nominal Tubing Size in.	PSI @ 73.4 °F	PSI @ 180 °F
1/4 PEX	752	336
1/2 PEX	480	215
5/8 and larger PEX	475	210

### Hydrostatic Sustained Pressure:

Fittings and pipe assembled and raised to min burst pressures at temperatures below:

#### PEX

Nominal Tubing Size in.	PSI @ 180 °F	Duration
1/4 PEX	305	1000 h
1/2 PEX	195	1000 h
5/8 and larger PEX	190	1000 h

#### CPVC

Nominal Tubing Size	PSI @ 180 °F	Duration
All	521	6 m
All	364	4 h

#### Copper

Nominal Tubing Size	PSI @ 200 °F	Duration
All	400	1000 h





## Thermo-Cycling:

Fittings and pipe assembled and immersed into varying temperatures. A constant air pressure of 100 psi will be applied to the assembly cycling between water reservoirs and ambient air 1000 times as listed below:

Copper, PEX, CPVC

Nominal Tubing Size	Condition Temperatures	Duration
All	Water immersion at 180°F	2 m
	Air immersion at ambient	2 m
	Water immersion at 60°F	2 m
	Air immersion at ambient	2 m

## Mechanical Separation:

Fittings and pipe assembled with longitudinal weight below:

Copper, PEX, CPVC

Nominal Tubing Size	Longitudinal Load Lbf	Duration
3/8	80	1 hr
1/2	120	1 hr
3/4	215	1 hr
1	375	1 hr
1-1/4	550	1 hr
1-1/2	785	1 hr
2	1320	1 hr

## Hydraulic Shock:

Fitting and pipe assembled subject to water hammer every two seconds as below:

Copper, PEX, CPVC

Nominal Tubing Size	Hydraulic Shock Pressure PSI	Cycles
All	375	1000



## THE SHARKBITE 2XL DESIGN (1-1/4" – 2")

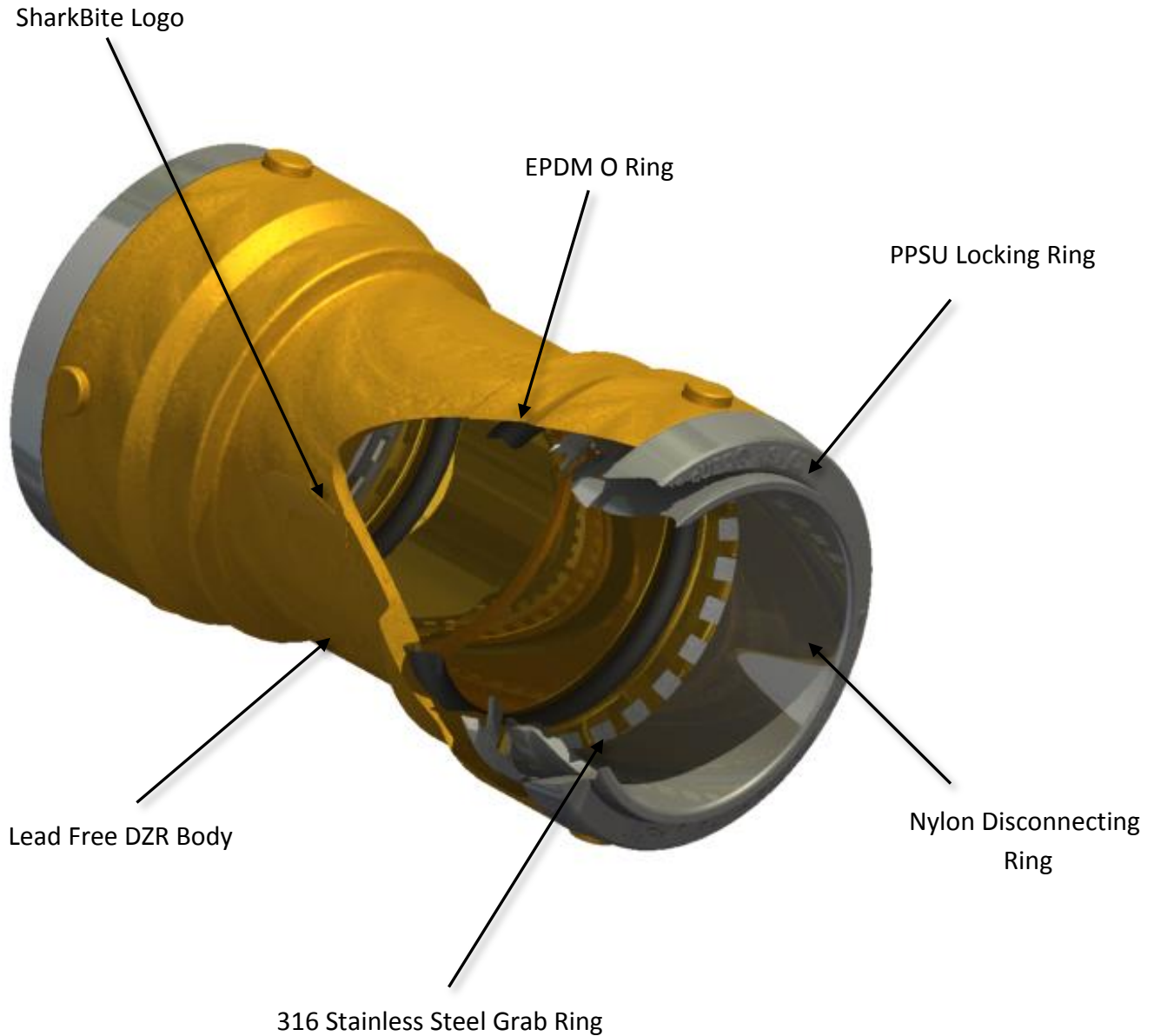

## WHY SHARKBITE 2XL?

- **Quick Connect:**
  - No tools, soldering, clamps, unions or glue required. Cut pipe square, de-burr to remove rough edges/debris, mark the pipe for correct depth and push to get a pressure ready connection every time.
- **Quick Disconnect:**
  - Disconnect in seconds by sliding the De-Mount Tool down the pipe to engage the demount lugs and rotate clockwise to lock the open position leaving both hands free, you can now remove the pipe.
- **SAFE-Recessed Release Collar:**
  - Commercial SharkBite require a special Demount Tool and cannot be accidentally disconnected/released.
- **Extensive Range Including Slip Feature on Couplings and Tee's:**
  - When repairing or tapping into existing pipe with "Push-Fittings" you must be able to either move the fitting or the pipe to ensure the pipe is engaged fully into the fitting. With rigid pipe like copper the only way with "Push-Fittings" is to have a SLIP feature to allow easy installation when tapping into existing pipe.
- **Easy Installation:**
  - Unlike the tool intensive connection methods there is NO need to send multiple fitters to a job, SharkBite 2XL has been designed to be installed or removed by one person. All fittings are lubricated for easy connection and by fitting the De-Mount Tool before engaging the pipe the force required can be reduced further. With the De-Mount Tool locked on you also have hands free disconnection. WET OR DRY: No waiting for copper tube to dry before soldering or glue to cure, SharkBite makes an instant connection in seconds.
- **No Tools:**
  - Unlike alternative tool intensive connections systems, SharkBite has no special tooling required for installation.
- **No Time:**
  - Fastest connection - CUT-PUSH-DONE.
  - Easy access to small or tight places.
  - No Flame - Does not require fire permit or fire marshal.
- **No Waste:**
  - Should you make an error or simply want to change your installation, no problem for SharkBite. Simply remove and re-use. (Fittings used for repeated testing must not be used in any permanent application).
- **Fittings Cannot be Disassembled:**
  - SharkBite 2XL Fittings are factory assembled and components cannot be removed.
- **Long Pipe Engagement:**
  - Provides pipe support against lateral pipe forces.
- **Lead Free (LF) Dezincification Resistance (DZR) Brass:**
  - Exceeds current no lead legislation - AB1953 or NSF372. Suitable for underground installation subject to local code authorities/inspectors. Dezincification properties (DZR) exceed ISO6509 and NSF-14.
- **Environmentally Friendly:**
  - Remove and re-use fittings, no need to be scrapped. No heat is required for installation.

## HOW TO MAKE A SHARKBITE 2XL CONNECTION

1. Cut copper, CPVC or PEX using a quality tuber or pipe cutter with a sharp blade.



2. Remove burrs and ensure pipe surface is free of scratches and any debris. It is critical that pipe be marked with the correct insertion depth as listed below:

1-1/4" Pipe Insertion Depth = 2"

1-1/2" Pipe Insertion Depth = 2-1/4"

2" Pipe Insertion Depth = 2-1/2"



3. Align pipe with the fitting, insert pipe while rotating either pipe or fitting.



4. SharkBite 2XL PEX Stiffener must be inserted into PEX pipe prior to fitting.



Connection is complete when pipe is fully inserted with depth insertion marked on pipe is still visible at the head of the fitting





## DISCONNECTING A SHARKBITE 2XL CONNECTION

1. Place the Shark Shifter De-Mount Tool on the pipe just above the connection. Then slide the tool down to engage lugs on the head of the fitting.



2. Rotate the Shark Shifter De-Mount Tool clockwise to lock onto the lugs. This will lock the Shark Shifter De-Mount Tool in place.



3. Rotate the Shark Shifter De-Mount Tool clockwise to lock onto the lugs. This will lock the Shark Shifter De-Mount Tool in place.



With the Shark Shifter De-Mount Tool Withdraw locked in place, pull the pipe from the fitting. Rotate the Shark Shifter De-Mount Tool counter-clockwise to remove the fitting.



## SHARKBITE 2XL DIMENSIONS

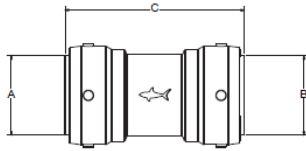

Coupling

P/N	A	B	C	Weight
SB0135	1¼"	1¼"	3.26"	0.84
SB0141	1½"	1½"	4.37"	1.15
SB0154	2"	2"	4.80"	1.56
SB013528	1¼"	1"	3.26"	0.69
SB014135	1½"	1¼"	4.37"	1.02
SB015441	2"	1½"	4.80"	1.42

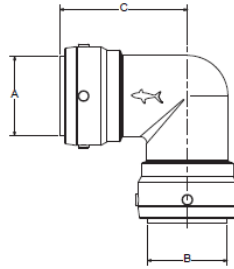

Elbow

P/N	A	B	C	Weight
SB0235	1¼"	1¼"	2.80"	1.07
SB0241	1½"	1½"	3.16"	1.52
SB0254	2"	2"	3.60"	2.18

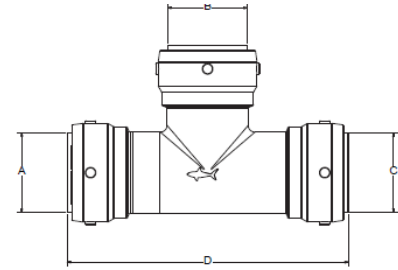

Tee

P/N	A	B	C	D	Weight
SB0335	1¼"	1¼"	1¼"	6.50"	1.61
SB0341	1½"	1½"	1½"	6.70"	2.26
SB0354	2"	2"	2"	7.99"	3.07
SB0335316	1¼"	½"	1¼"	6.70"	1.25
SB0335322	1¼"	¾"	1¼"	6.70"	1.28
SB0335328	1¼"	1"	1¼"	6.70"	1.42
SB03414122	1½"	¾"	1½"	7.39"	1.78
SB03414128	1½"	1"	1½"	7.39"	1.92
SB03414135	1½"	1¼"	1½"	7.39"	2.08
SB03545428	2"	1"	2"	7.99"	2.55
SB03545435	2"	1¼"	2"	7.99"	2.72
SB03545441	2"	1½"	2"	7.99"	2.86

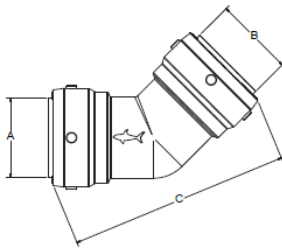

45° Elbow

P/N	A	B	C	Weight
SB0535	1¼"	1¼"	5.15"	0.97
SB0541	1½"	1½"	5.77"	1.35
SB0554	2"	2"	6.50"	1.91

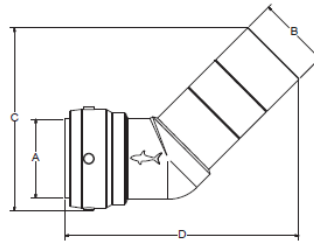

Street 45° Elbow

P/N	A	B	C	D	Weight
SB0735	1¼"	1¼"	4.24"	5.45"	0.97
SB0741	1½"	1½"	4.70"	6.05"	1.35
SB0754	2"	2"	5.30"	6.74"	1.91

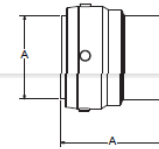

End Stop

P/N	Size	A	Weight
SB0435	1¼"	2.35"	0.57
SB0441	1½"	2.62"	0.82
SB0554	2"	2.89"	1.25

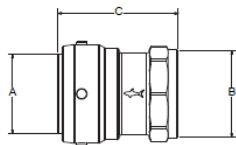

Female Connector

P/N	A	B	C	Weight
SB113532F	1¼"	1¼" FNPT	2.98"	0.72
SB114140F	1½"	1½" FNPT	3.21"	0.92
SB115450F	2"	2" FNPT	3.42"	1.23

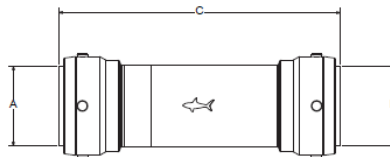

Slip Coupling

P/N	A	B	C	Weight
SB0635	1¼"	1¼"	6.69"	1.20
SB0641	1½"	1½"	7.40"	1.71
SB0654	2"	2"	7.98"	2.33



Demount Clip

P/N	Size	A	Weight
SBDC35	1¼"	2.70"	0.07
SBDC41	1½"	2.94"	0.08
SBDC54	2"	2.45"	0.09

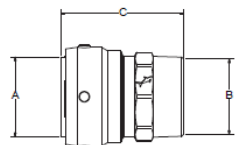

Male Connector

P/N	A	B	C	Weight
SB113532M	1¼"	1¼" MNPT	3.03"	0.71
SB114140M	1½"	1½" MNPT	3.20"	0.89
SB115450M	2"	2" MNPT	3.43"	1.20

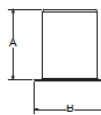

Pex Stiffener

P/N	Size	A	B	Weight
SBLT35	1¼"	1.65"	1.34"	0.08
SBLT41	1½"	1.89"	1.59"	0.10
SBLT54	2"	2.09"	2.09"	0.15

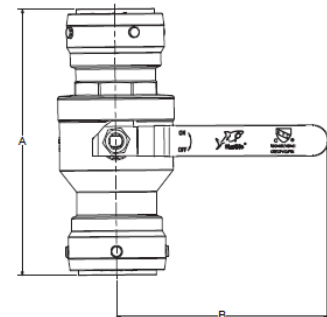

Ball Valve

P/N	Size	A	B	Weight
SBBV435	1¼"	6.08"	5.10"	2.06
SBBV441	1½"	6.79"	6.10"	2.99
SBBV454	2"	7.58"	6.16"	4.45

\* All weights are in pounds



## SHARKBITE 2XL PRESSURE LOSS AND FLOW RATES

Sharkbite 1/4" Connectors  
using Copper pipe

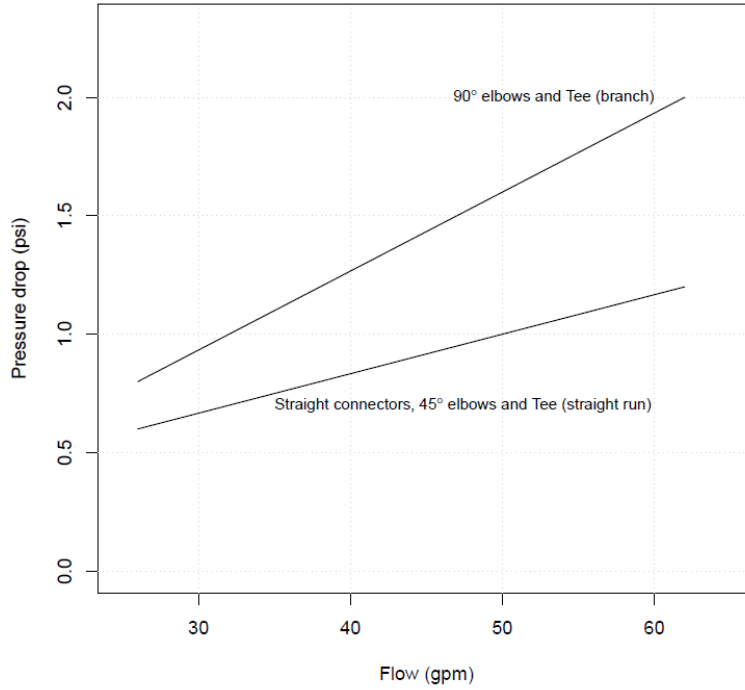

Sharkbite 1/4" Connectors  
using PEX pipe

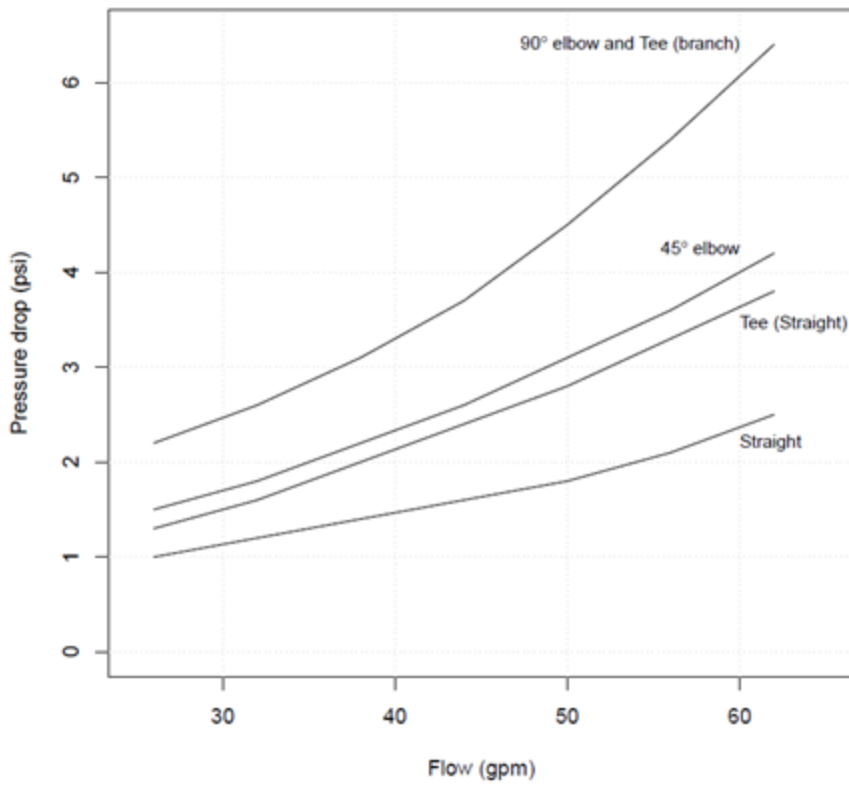



## Sharkbite 1½" Connectors using Copper pipe

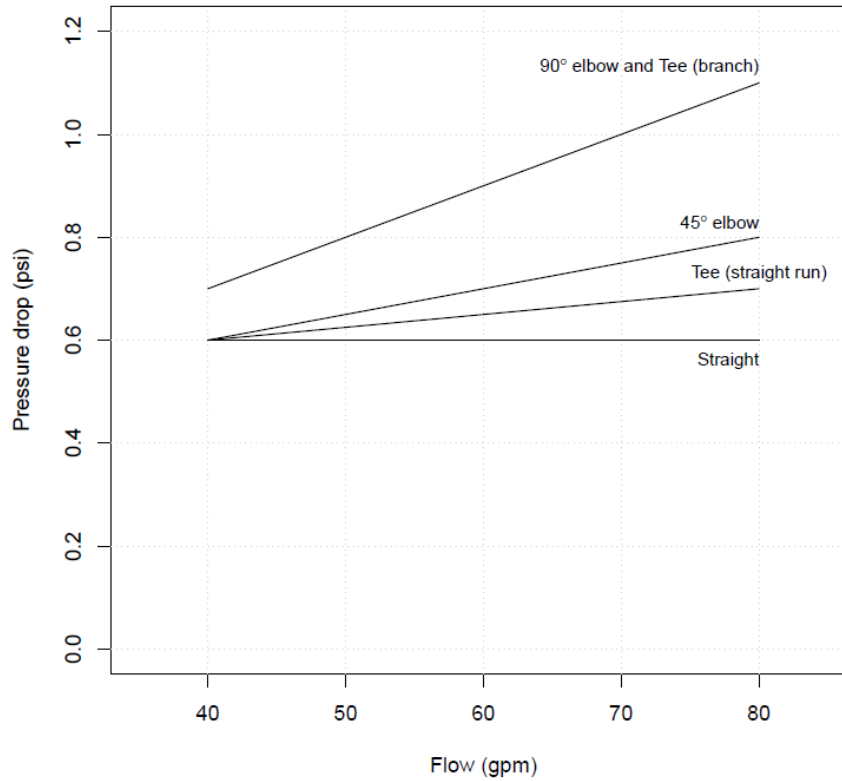

## Sharkbite 1½" Connectors using PEX pipe

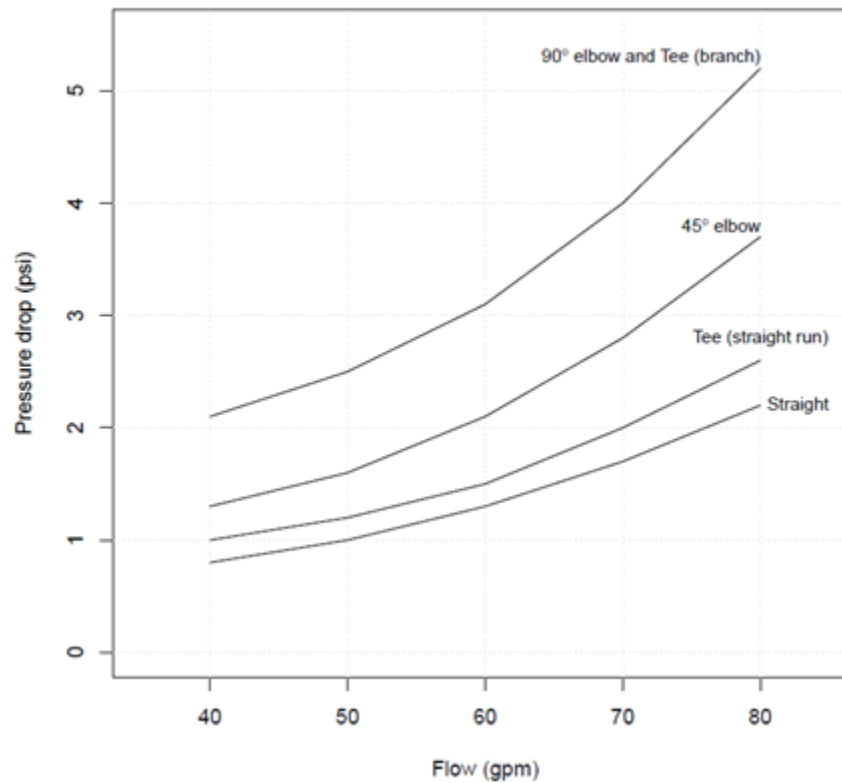





**Sharkbite 2" Connectors  
using Copper pipe**

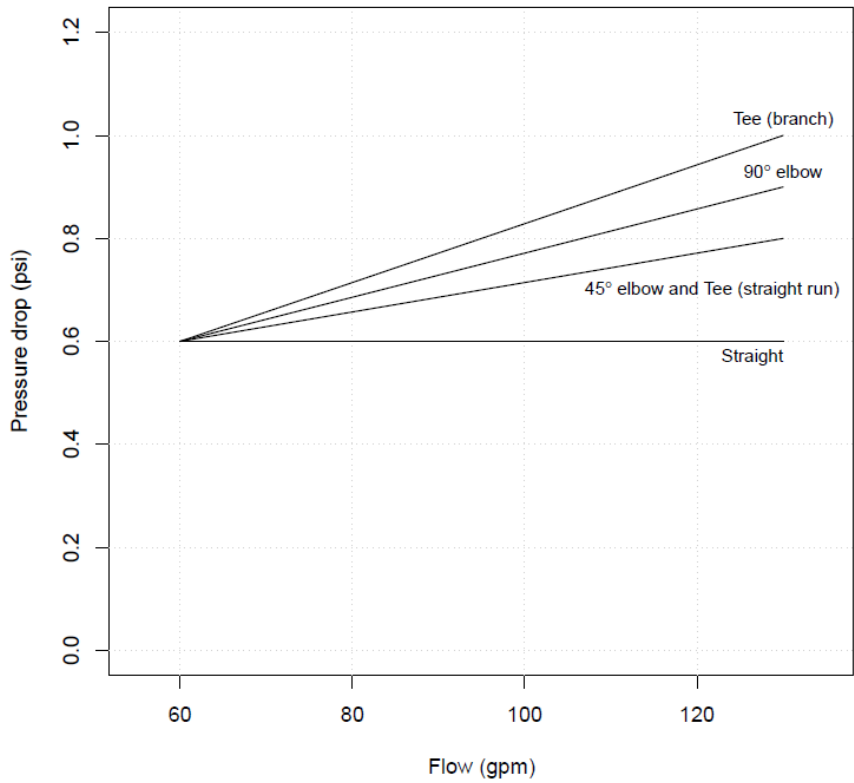

**Sharkbite 2" Connectors  
using PEX pipe**

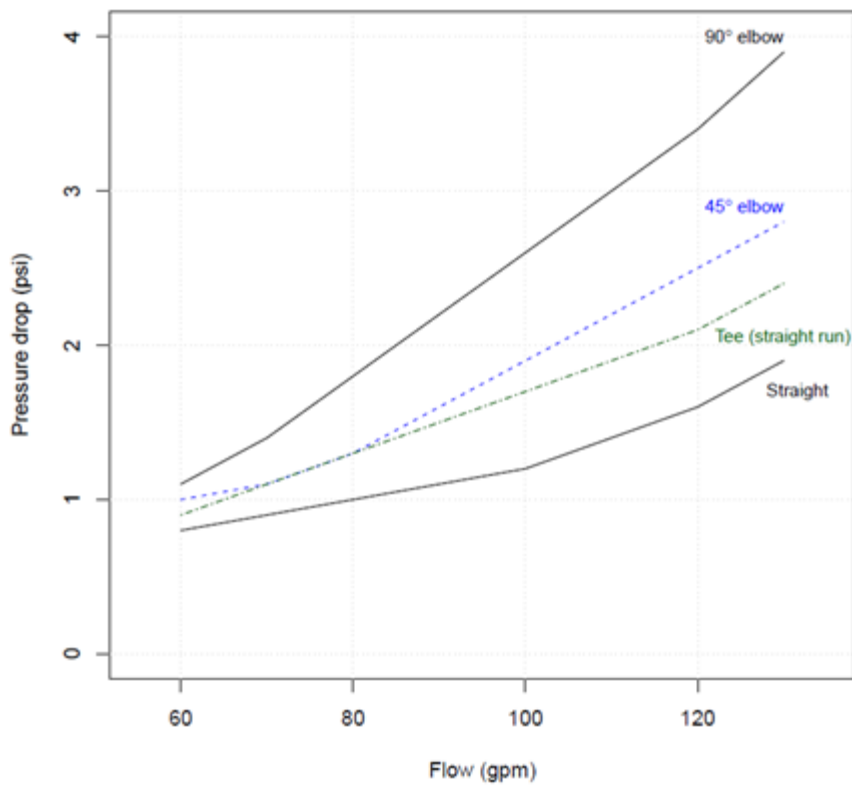

## SHARKBITE PEX TUBING

SharkBite PEX tubing is a cross-linked polyethylene tubing for a wide range of residential and commercial plumbing applications. Manufactured without an oxygen barrier for potable water systems (available in white, blue, and red) and with an oxygen barrier for radiant floor and hydronic heating applications (available in orange). The oxygen diffusion barrier applied to the exterior limits oxygen permeation through the tubing wall in hydronic heating applications which prevents corrosion of ferrous metal parts in the heating system.



### FEATURES AND BENEFITS

- Flexible: Easy to install and service.
- Quieter: Minimizes noise caused by water hammer.
- Resists corrosion and scale buildup: Improves the performance of the plumbing system.
- Fewer fittings required: Reduces total installation cost.
- Fewer joints: Reduces the chances of call backs.
- Pressure test immediately: No waiting for glue to dry or joints to cool

A repeating SharkBite imprint pattern provides a visual aid to determine if the tube has been inserted all the way into the SharkBite Push-Fit Fitting. This feature only works if the tubing is cut between the SharkBite imprint pattern.



### CERTIFICATIONS

The SharkBite tubing with and without oxygen barrier is approved for use in all model codes in the US and Canada for use in hydronic and potable water systems and is certified to the following standards:

- NSF 14/61,
- NSF P171,
- ASTM F 876,
- ASTM F 877,
- CSA B137.5
- AWWA C904.



## PEX PIPE SPECS AND DIMENSIONS

Model	Nominal Tubing Size				Length		Bend Radius		Fluid Capacity Per 100'		Package Weight	
	ID		OD		FT	M	in	mm	gal	ltrs	lbs	kgs
	in	mm	in	mm								
Blue PEX (Coil)												
U860B100	1/2	13	5/8	16	100	30.48	5	127	0.96	3.63	5.5	2.5
U860B300	1/2	13	5/8	16	300	91.44	5	127	0.96	3.63	14.5	6.6
U860B500	1/2	13	5/8	16	500	152.4	5	127	0.96	3.63	24	10.9
U870B100	3/4	19	7/8	22	100	30.48	7	178	1.9	7.19	10.5	4.8
U870B300	3/4	19	7/8	22	300	91.44	7	178	1.9	7.19	31.5	14.4
U870B500	3/4	19	7/8	22	500	152.4	7	178	1.9	7.19	45	20.4
U880B100	1	25	1-1/8	29	100	30.48	10	254	3.1	11.73	18	8.2
U880B300	1	25	1-1/8	29	300	91.44	10	254	3.1	11.73	54	24.6
U880B500	1	25	1-1/8	29	500	152.4	10	254	3.1	11.73	90	40.8
Red PEX (Coil)												
U860R100	1/2	13	5/8	16	100	30.48	5	127	0.96	3.63	5.5	2.5
U860R300	1/2	13	5/8	16	300	91.44	5	127	0.96	3.63	14.5	6.6
U860R500	1/2	13	5/8	16	500	152.4	5	127	0.96	3.63	24	10.9
U870R100	3/4	19	7/8	22	100	30.48	7	178	1.9	7.19	10.5	4.8
U870R300	3/4	19	7/8	22	300	91.44	7	178	1.9	7.19	31.5	14.4
U870R500	3/4	19	7/8	22	500	152.4	7	178	1.9	7.19	45	20.4
U880R100	1	25	1-1/8	29	100	30.48	10	254	3.1	11.73	18	8.2
U880R300	1	25	1-1/8	29	300	91.44	10	254	3.1	11.73	54	24.6
U880R500	1	25	1-1/8	29	500	152.4	10	254	3.1	11.73	90	40.8
White PEX (Coil)												
U860W100	1/2	13	5/8	16	100	30.48	5	127	0.96	3.63	5.5	2.5
U860W300	1/2	13	5/8	16	300	91.44	5	127	0.96	3.63	14.5	6.6
U860W500	1/2	13	5/8	16	500	152.4	5	127	0.96	3.63	24	10.9
U870W100	3/4	19	7/8	22	100	30.48	7	178	1.9	7.19	10.5	4.8
U870W300	3/4	19	7/8	22	300	91.44	7	178	1.9	7.19	31.5	14.4
U870W500	3/4	19	7/8	22	500	152.4	7	178	1.9	7.19	45	20.4
U880W100	1	25	1-1/8	29	100	30.48	10	254	3.1	11.73	18	8.2

# SHARKBITE PUSH-FIT CONNECTION SYSTEM



Model	Nominal Tubing Size				Length		Bend Radius		Fluid Capacity Per 100'		Package Weight	
	ID		OD		FT	M	in	mm	gal	ltrs	lbs	kgs
	in	mm	in	mm								
White PEX (Coil)												
U880W300	1	25	1-1/8	29	300	91.44	10	254	3.1	11.73	54	24.6
U880W500	1	25	1-1/8	29	500	152.4	10	254	3.1	11.73	90	40.8
U885W100	1-1/4	31.75	1-3/8	35	100	30.48	7	175	4.67	17.68	25	11.34
U890W100	1-1/2	38.1	1-5/8	41	100	30.48	8	206	6.5	24.61	35	15.88
U895W100	2	50.8	2-1/4	54	100	30.48	11	270	11.4	43.15	60	27.22
Blue PEX (Straight Lengths)												
U860B5	1/2	13	5/8	16	5	1.52	5	127	0.96	3.63	3	1.4
U860B10	1/2	13	5/8	16	10	3.04	5	127	0.96	3.63	6	2.7
U860B20	1/2	13	5/8	16	20	6.09	5	127	0.96	3.63	12	5.5
U870B5	3/4	19	7/8	22	5	1.52	7	178	1.9	7.19	5.25	2.5
U870B10	3/4	19	7/8	22	10	3.04	7	178	1.9	7.19	10.5	4.8
U870B20	3/4	19	7/8	22	20	6.09	7	178	1.9	7.19	21	9.5
U880B5	1	25	1-1/8	29	5	1.52	10	254	3.1	11.73	4.5	2
U880B10	1	25	1-1/8	29	10	3.04	10	254	3.1	11.73	8.8	4
U880B20	1	25	1-1/8	29	20	6.09	10	254	3.1	11.73	17.4	7.9
Red PEX (Straight Lengths)												
U860R5	1/2	13	5/8	16	5	1.52	5	127	0.96	3.63	3	1.4
U860R10	1/2	13	5/8	16	10	3.04	5	127	0.96	3.63	6	2.7
U860R20	1/2	13	5/8	16	20	6.09	5	127	0.96	3.63	12	5.5
U870R5	3/4	19	7/8	22	5	1.52	7	178	1.9	7.19	5.25	2.5
U870R10	3/4	19	7/8	22	10	3.04	7	178	1.9	7.19	10.5	4.8
U870R20	3/4	19	7/8	22	20	6.09	7	178	1.9	7.19	21	9.5
U880R5	1	25	1-1/8	29	5	1.52	10	254	3.1	11.73	4.5	2
U880R10	1	25	1-1/8	29	10	3.04	10	254	3.1	11.73	8.8	4
U880R20	1"	25	1-1/8	29	20	6.09	10	254	3.1	11.73	17.4	7.9
White PEX (Straight Lengths)												
U860W10	1/2	13	5/8	16	10	3.04	5	127	0.96	3.63	6	2.7
U860W20	1/2	13	5/8	16	20	6.09	5	127	0.96	3.63	12	5.5
U870W5	3/4	19	7/8	22	5	1.52	7	178	1.9	7.19	5.25	2.5
U870W10	3/4	19	7/8	22	10	3.04	7	178	1.9	7.19	10.5	4.8
U870W20	3/4	19	7/8	22	20	6.09	7	178	1.9	7.19	21	9.5
U880W5	1	25	1-1/8	29	5	1.52	10	254	3.1	11.73	4.5	2
U880W10	1	25	1-1/8	29	10	3.04	10	254	3.1	11.73	8.8	4
U880W20	1	25	1-1/8	29	20	6.09	10	254	3.1	11.73	17.4	7.9
U885W20	1-1/4	31.75	1-3/8	35	20	6.10	7	175	4.76	7.68	25	11.34
U890W20	1-1/2	38.1	1-5/8	41	20	6.10	8	206	6.5	24.61	35	15.88
U895W20	2	50.8	2-1/4	54	20	6.10	11	270	11.4	43.15	36	16.33



## PROJECT PROFILE

### Soleil Skyscraper

Location: Brisbane, Australia

Height: 797 FT

# of Floors: 74

Architect: DBI Design

Developer: Meriton Group

Main Contractor: Karimbla Building Services (Meriton Subsidiary)

Plumbing Contractor: Isle Plumbing

Product Used: SharkBite Pipes and Fittings



## PROJECT PROFILE

### Infinity Tower

Location: Brisbane, Australia

Height: 817 FT

# of Floors: 81

Developer: Meriton Group

Main Contractor: Meriton Group

Plumbing Contractor: Isle Plumbing

Product Used: SharkBite Pipes and Fittings

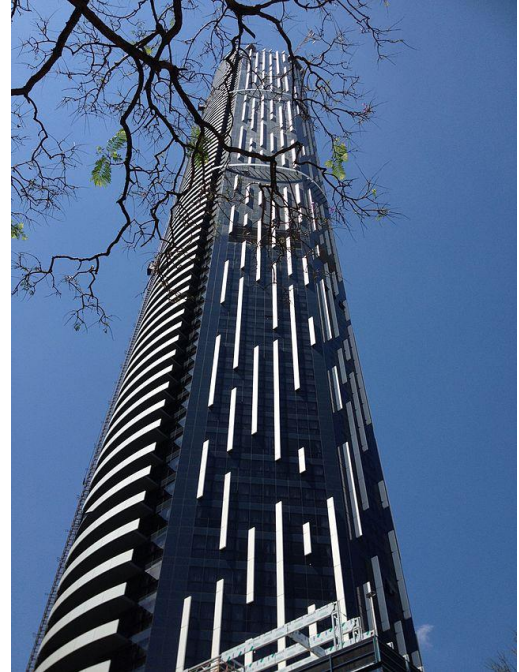



## IAPMO RESEARCH AND TESTING, INC.

5001 E. Philadelphia Street, Ontario, CA 91761-2816 • (909) 472-4100 • Fax (909) 472-4244 •  
[www.iapmort.org](http://www.iapmort.org)

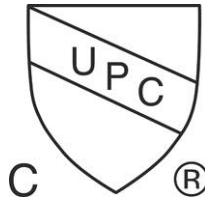

## CERTIFICATE OF LISTING

IAPMO Research and Testing, Inc. is a product certification body which tests and inspects samples taken from the supplier's stock or from the market or a combination of both to verify compliance to the requirements of applicable codes and standards. This activity is coupled with periodic surveillance of the supplier's factory and warehouses as well as the assessment of the supplier's Quality Assurance System. This listing is subject to the conditions set forth in the characteristics below and is not to be construed as any recommendation, assurance or guarantee by IAPMO Research and Testing, Inc. of the product acceptance by Authorities Having Jurisdiction.

Effective Date: July 2015 -Rev. 10/2/2015- Void After: July 2016

Product: Push Fit Fittings File No. 4630

Issued To: Cash Acme/Reliance Worldwide  
2400 7TH AVE. SW  
CULLMAN, AL 35055

Identification: Each fitting shall have the following information marked on it where it will be visible after it has been installed:  
Name of manufacturer or trademark.  
When a fitting is not suitable for all four (4) materials, it shall be marked as follows for the materials for which they are suitable:  
- Copper or Cu  
- CPVC  
- PEX  
- PE-RT  
When push-fit connectors are used on plumbing devices, the markings are permitted to be on the plumbing device.

Fittings 1/2" CTS or smaller are permitted to use a permanent label complying with the requirements of UL 969 or CSA C22.2 N. 0.15 to display the required markings. The markings shall be permanent. The product shall also bear the cUPC mark.

Characteristics: Push fit fittings that have a quick assembly push fit mechanism that can be used with Copper, PEX and CPVC tubing and pipes. Fittings for use in domestic and commercial application for both potable water distribution systems and hydronic heating systems. Push fit fittings can be utilized in underground applications and as manufactured joints without access panels. To be installed in accordance with the manufacturer's instructions and the latest edition of the Uniform Plumbing Code and the National Plumbing Code of Canada.

# SHARKBITE PUSH-FIT CONNECTION SYSTEM



Products listed on this certificate have been tested by an IAPMO R&T recognized laboratory. This recognition has been granted based upon the laboratory's compliance to the applicable requirements of ISO/IEC 17025.

Products are in compliance with the following code(s):

Uniform Plumbing Code (UPC®)  
National Plumbing Code of Canada  
International Plumbing Code (IPC®)

Products are in compliance with the following standard(s):

ASSE 1061-2011

MODELS:

**Note: The requirements of Section 609.3.2 in the Uniform Plumbing Code are satisfied for push fit fittings by section 301.4.1 of the same Uniform Plumbing Code when installed in accordance with the manufacturer's installation guides.**

**Note: All 1/2" through 1" models comply with ANSI/NSF 14.**

For a complete list of compliant models and the most up to date listing, please visit

[http://pld.iapmo.org/file\\_info.asp?file\\_no=0004630](http://pld.iapmo.org/file_info.asp?file_no=0004630)



# SHARKBITE PUSH-FIT CONNECTION SYSTEM



5001 E. Philadelphia Street, Ontario, CA 91761-2816 • (909) 472-4100 • Fax (909) 472-4244 •  
www.iapmort.org



## CERTIFICATE OF LISTING

IAPMO Research and Testing, Inc. is a product certification body which tests and inspects samples taken from the supplier's stock or from the market or a combination of both to verify compliance to the requirements of applicable codes and standards. This activity is coupled with periodic surveillance of the supplier's factory and warehouses as well as the assessment of the supplier's Quality Assurance System. This listing is subject to the conditions set forth in the characteristics below and is not to be construed as any recommendation, assurance or guarantee by IAPMO Research and Testing, Inc. of the product acceptance by Authorities Having Jurisdiction.

Effective Date: October 2015 Void After: October 2016

Product: Lead Free Plumbing Products File No. 6544

Issued To: CASH ACME/RELIANCE WORLDWIDE  
2400 7TH AVE. SW  
CULLMAN, AL 35055

Identification: Each product shall bear permanent and legible markings to identify the manufacturer. This marking shall be the trade name, trademark, or other mark known to identify the manufacturer. The product and/or product packaging may also bear the term "Lead Plumbing Law", "Complies with Lead Plumbing Law", or either "Lead Free" or "Low Lead" above or in close proximity to the appropriate IAPMO R&T certification mark, or the term "Certified by IAPMO R&T". The product packaging may also bear a grey dot, a check mark with circle, or any other home centers marking requirements.

Characteristics: Products may include any pipe, pipe fitting, solder, flux, or other plumbing products providing water for human consumption. Products listed below are to be installed in accordance with the manufacturer's instruction. These products have been verified with weighted average lead content  $\leq 0.25\%$ ; Solder and flux lead content  $\leq 0.2\%$ .

Products listed on this certificate have been tested by an IAPMO R&T recognized laboratory. This recognition has been granted based upon the laboratory's compliance to the applicable requirements of ISO/IEC 17025.

Products are in compliance with the following standard(s):

Section 1417(d) of the Safe Drinking Water Act  
The lead content requirements of Section 116875 of the California Health & Safety Code  
NSF/ANSI 372-2011

For a complete list of compliant models and the most up to date listing, please visit

[http://pld.iapmo.org/file\\_info.asp?file\\_no=0006544](http://pld.iapmo.org/file_info.asp?file_no=0006544)



## IAPMO RESEARCH AND TESTING, INC.

5001 E. Philadelphia Street, Ontario, CA 91761-2816 • (909) 472-4100 • Fax (909) 472-4244 •  
www.iapmort.org



NSF/ANSI 61

### CERTIFICATE OF LISTING

IAPMO Research and Testing, Inc. is a product certification body which tests and inspects samples taken from the supplier's stock or from the market or a combination of both to verify compliance to the requirements of applicable codes and standards. This activity is coupled with periodic surveillance of the supplier's factory and warehouses as well as the assessment of the supplier's Quality Assurance System. This listing is subject to the conditions set forth in the characteristics below and is not to be construed as any recommendation, assurance or guarantee by IAPMO Research and Testing, Inc. of the product acceptance by Authorities Having Jurisdiction.

Effective Date: December 2014 -Rev. 9/22/2015- Void After: December 2015

Product: Drinking Water System Components - Health Effects File No. N-4630

Issued To: Cash Acme/Reliance Worldwide  
2400 7TH AVE. SW  
CULLMAN, AL 35055

Identification: Each product shall be permanently and legibly marked with the manufacturer's name or trademark. The product may also be marked with the standard designation "NSF/ANSI 61".

Characteristics: Materials or products that come into contact with drinking water and/or drinking water treatment chemicals. Products and materials may include process media, protective materials, joining and sealing materials, pipes and related products, mechanical devices used with treatment/transmission/distribution systems, and mechanical plumbing devices. To be installed in accordance with the manufacturer's instruction. Lead free requirements are addressed under a separate certificate of listing.

Products listed on this certificate have been tested by an IAPMO R&T recognized laboratory. This recognition has been granted based upon the laboratory's compliance to the applicable requirements of ISO/IEC 17025.

Products are in compliance with the following standard(s):

NSF/ANSI 61-2013

For a complete list of compliant models and the most up to date listing, please visit

[http://pld.iapmo.org/file\\_info.asp?file\\_no=N4630](http://pld.iapmo.org/file_info.asp?file_no=N4630)

# SHARKBITE PUSH-FIT CONNECTION SYSTEM



5001 E. Philadelphia Street, Ontario, CA 91761-2816 • (909) 472-4100 • Fax (909) 472-4244 •  
www.iapmort.org

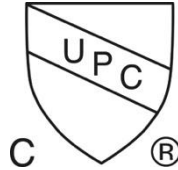

## CERTIFICATE OF LISTING

IAPMO Research and Testing, Inc. is a product certification body which tests and inspects samples taken from the supplier's stock or from the market or a combination of both to verify compliance to the requirements of applicable codes and standards. This activity is coupled with periodic surveillance of the supplier's factory and warehouses as well as the assessment of the supplier's Quality Assurance System. This listing is subject to the conditions set forth in the characteristics below and is not to be construed as any recommendation, assurance or guarantee by IAPMO Research and Testing, Inc. of the product acceptance by Authorities Having Jurisdiction.

Effective Date: December 2014 -Rev. 10/7/2015- Void After: December 2015

Product: Crosslinked Polyethylene (PEX) Tubing File No. 9143

Issued To: CASH ACME/RELIANCE WORLDWIDE  
2400 7TH AVE. SW  
CULLMAN, AL 35055

Identification: The tubing shall be marked with the manufacturer's name or trademark, ASTM F876, PEX, pressure rating at 180°F, nominal size, SDR 9, and a code number identifying the compound and the date of manufacture. The tubing intended for use in potable water shall be marked with the seal or mark of the laboratory marking the evaluation. Marking shall be spaced at intervals of not more than 5 feet. Tubing shall be marked with the cUPC® certification mark.

Characteristics: Crosslinked polyethylene (PEX) tubing that is outside diameter controlled, made in standard thermoplastic tubing dimension ratios (SDR 9), and pressure rated for water at three temperature. 630 psi (4.34 MPa at 73.4°F (23°C) 400 psi (2.76 MPa at 180°F (82.2°C) 315 psi (2.17 MPa at 200°F (93.3°C)). May be used in radiant floor and baseboard heating applications. To be installed in accordance with the manufacturer's instructions and the requirements of the latest edition of the Uniform Plumbing Code® and the National Plumbing Code of Canada.

Products listed on this certificate have been tested by an IAPMO R&T recognized laboratory. This recognition has been granted based upon the laboratory's compliance to the applicable requirements of ISO/IEC 17025.

Products are in compliance with the following code(s):

Uniform Plumbing Code (UPC®)  
National Plumbing Code of Canada

Products are in compliance with the following standard(s):

ASTM F876-2013a and CSA B137.5-2013

For a complete list of compliant models and the most up to date listing, please visit

[http://pld.iapmo.org/file\\_info.asp?file\\_no=0007143](http://pld.iapmo.org/file_info.asp?file_no=0007143)

## WARRANTY

# LIMITED WARRANTY

## SharkBite® And Cash Acme® Products

### WHAT DOES THIS WARRANTY COVER?

Subject to conditions outlined in this statement, RWC (in the USA, Reliance Worldwide Corporation and in Canada, Reliance Worldwide Corporation (Canada) Inc.) warrants to owners of real property in the United States and Canada that SharkBite® and Cash Acme® products, when used and installed in accordance with the requirements set forth below, to be free from defects in material and workmanship for the applicable Warranty Period. This Limited Warranty is in effect for installations made after July 1, 2015 and is applicable to product installed in the country it was purchased.

Proof of purchase is required to validate the warranty period; if proof of purchase is not available, the warranty period shall default to the date of manufacture for each product.

### WHAT ARE THE CONDITIONS OF THIS WARRANTY?

1. All products must be installed in accordance with all then applicable codes, good plumbing practice, in accordance with any local, state, provincial or federal requirements, and installed in a potable water or radiant heating application unless a non-potable water service is specifically allowed for in the pertinent product literature.
2. The installing contractor must use construction techniques compliant with then applicable codes to install the range of products and use the product(s) within the design parameters specified in any installation guidelines and technical notes for the applicable system. This shall include field pressure testing prior to concealing with concrete or by other means. Failure to install RWC products according to manufacturer's installation instruction will void all applicable warranties and may result in severe water damage. Installation of RWC's SharkBite® EvoPEX Evolutionary PEX Push Fittings must be completed by a licensed plumbing contractor.
3. Products must not be installed in a system that may operate at temperatures or at pressures that exceed the printed rating on the product, packaging or installation instructions.
4. Without limiting the foregoing, this Limited Warranty does not apply if the product failure or resulting damage is caused by: (a) evidence of tampering, mishandling, neglect, accidental damage, freeze damage (it is expressly understood that failure as a result of any freezing fluids within the pipes does not constitute a defect in material or workmanship and shall not be covered by this warranty) or unauthorized modifications or repairs that cause damage to RWC warranted products; (b) exposure to harmful, unauthorized, or unanticipated chemicals or substances or corrosive water conditions; (c) exposure to ultraviolet light; (d) faulty installation including failure to follow proper burial instructions; (e) damage from faulty operating conditions; (f) components not manufactured or sold by RWC; and (g) acts of nature such as earthquakes, fire, flood or lightning.
5. Although RWC provides a plumbing system to facilitate a complete installation, other manufacturers pipe and/or fittings may be installed in any given installation provided manufacturing of the pipe and/or fittings demonstrates compliance with the applicable ASTM/CSA standards, and the product has been certified by a recognized third-party testing agency. The RWC product in the given installation will continue to be covered under this Limited Warranty although limits on Warranty Period may apply. RWC will be responsible only for proven defects in material or workmanship in RWC products. Problems in products manufactured by another company should be reported to that manufacturer. RWC does not warrant the integrity or workmanship of the contractor/installer.

### HOW DO YOU GET SERVICE?

In order to be eligible for service under this Limited Warranty you must return the defective product within thirty (30) days after detection of alleged failure or defect occurring within applicable warranty period (with shipping charges prepaid) to the original place of purchase. You also must include the model number of the product, the original date of purchase, proof of purchase and the nature of the problem. Products returned without shipping charges prepaid will be refused. For questions or inquiries to the Manufacturer, in the U.S. call 1-877- 700-4242 and in Canada 1-888-820-0120.

### WHAT WILL RWC DO?

If, after inspection, we find that a product covered by this limited warranty has failed due to a defect in material or workmanship during the specified warranty period, we will repair or replace, at our sole option, free of charge, the defective product during normal working hours and through a place of business as determined by RWC. This shall constitute the sole and exclusive remedy for any defective product.

### WHAT DOES THIS LIMITED WARRANTY NOT COVER?

RWC shall not be responsible for any incidental, indirect, contingent, special or consequential damages, including without limitation, lost profits or the cost of repairing or replacing other property which is damaged if these warranted products do not work properly, other costs resulting from labor charges, delays, vandalism, negligence, fouling caused by foreign material, damage from adverse water conditions, adverse chemical environments, or any other circumstances over which RWC has no control. This limitation applies even if RWC could have foreseen or has been advised of the possibility of these damages. This Limited Warranty shall be invalidated by any abuse, misuse, misapplication or improper installation of the product.

### HOW DOES STATE/PROVINCIAL LAW APPLY?

Some States/Provinces do not allow limitations on how long an implied warranty lasts, and some States/Provinces do not allow the exclusion or limitation of incidental or consequential damages. Therefore, the above limitations may not apply to you. This Limited Warranty gives you the specific legal rights, and you may have other rights that vary from State/Province to State/Province. You should consult applicable State/Provincial laws to determine your rights.

SO FAR AS IS CONSISTENT WITH APPLICABLE STATE/<sup>PROVINCIAL</sup>/ FEDERAL LAW, THE EXPRESS WARRANTY SET FORTH HEREIN IS THE ONLY WARRANTY GIVEN BY RWC WITH RESPECT TO THE SHARKBITE® AND CASH ACME® PRODUCTS AND RWC MAKES NO OTHER WARRANTIES, EXPRESSED OR IMPLIED, AND HEREBY SPECIFICALLY DISCLAIMS ALL OTHER WARRANTIES, EXPRESSED OR IMPLIED, INCLUDING BUT NOT LIMITED TO THE IMPLIED WARRANTIES OF MERCHANTABILITY AND FITNESS FOR A PARTICULAR PURPOSE.

# SHARKBITE PUSH-FIT CONNECTION SYSTEM



## HOW LONG DOES THE LIMITED WARRANTY COVERAGE LAST?

CATEGORY	SUBCATEGORY	WARRANTY PERIOD (FROM COMMENCEMENT DATE)	COMMENTS
SharkBite Universal Brass Push-To-Connect Fittings And SharkBite 2XL Large Diameter Push-To-Connect Fittings	Fittings	Twenty-Five (25) Years	Shall be used with: Copper–ASTM B 88 hard drawn copper tube K, L, and M PEX–ASTM F876/CSA B137.5 CPVC–ASTM D2846 or CSA B137.6 PE-RT–ASTM F2769
	Fittings	Five (5) Years	Shall be used with: HDPE SDR-9 ASTM D2737
SharkBite PEX Pipe	–	Twenty-Five (25) Years	Shall be used with: ASSE 1061, ASTM F1807, ASTM F2098, and ASTM F2159 Fittings
SharkBite Barb Fittings	Brass PEX Barb Fittings/ Copper Manifold	Five (5) Years	Shall be used on: PEX – ASTM F876/CSA B137.5 Copper Crimp Rings – ASTM F1807 Stainless Steel Clamp Rings – ASTM F2098
	Poly PEX Barb Fittings	Five (5) Years	Shall be used on: PEX – ASTM F876/CSA B137.5 Copper Crimp Rings – ASTM F2159 Stainless Steel Clamp Rings – ASTM F2098
	PEX Barb Tools	One (1) Year	From date of purchase.
Cash Acme® Products	Thermostatic Mixing Valves	Five (5) Years	Shall be installed per installation instructions.
	Other Cash Acme®	Two (2) Years	Shall be installed per installation instructions.
Valves with SharkBite Push-To-Connect Connections	Ball Valves, Supply Hoses, Supply Stops	Two (2) Years	Shall be installed per installation instructions.
Valves with SharkBite Push-To-Connect Connections Continued	Thermostatic Mixing Valves	Five (5) Years	Shall be installed per installation instructions.
	Other Cash Acme®	Two (2) Years	Shall be installed per installation instructions.
	SharkBite Connection	Twenty-Five (25) Years	Shall be used with: Copper - ASTM B 88 HARD DRAWN Copper Tube Type K, L, AND M PEX – ASTM F876/CSA B137.5 CPVC - ASTM D 2846 OR CSA B137.6 PE-RT - ASTM F2769
	SharkBite Connection	Five (5) Years	Shall be used with: HDPE SDR-9 ASTM D2737



Reliance Worldwide Corporation

**Reliance Worldwide USA**

2727 Paces Ferry Road SE Suite 1800 Building 2  
Atlanta, GA 30339  
Phone: 1-877-700-4242 • Fax: 1-877-700-4280  
[www.rwc.com](http://www.rwc.com)



[www.sharkbite.com](http://www.sharkbite.com)

Manufactured and Distributed by Reliance Worldwide Corporation