

ASSEMBLY & INSTALLATION INSTRUCTIONS

Fixture
BWS27320

SCHONBEK
Beyond

Fig. 3 Wiring

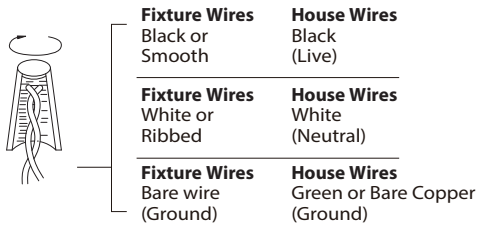
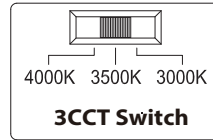
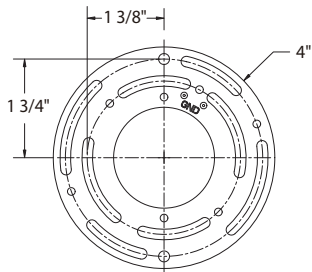

Fig. 4 Switch



Mounting Ring Dimensions



Adapter Plate Dimensions

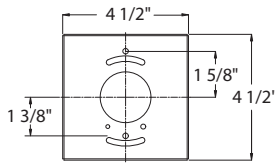

Mounting Back Plate

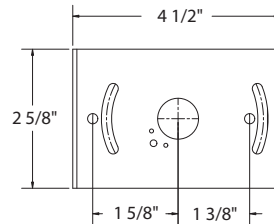

WARNING

IMPORTANT: NEVER attempt any work without shutting off the electricity.

- Read all instructions before installing.
- System is intended for installation in accordance with the National Electrical Code (NEC), other applicable installation code(s) and local regulations by a licensed electrician familiar with the operation of the product and the hazards involved.
- Go to the main fuse box, or circuit breaker panel. Place the main power switch in the "OFF" position and unscrew the fuse (s) or switch "OFF" the circuit breaker switch (es) that control the power to the fixture (s) or room that you are working on.
- Place the wall switch in the "OFF" position.

FAILURE TO INSTALL THIS FIXTURE IN ACCORDANCE WITH THESE INSTRUCTIONS MAY RESULT IN SERIOUS PERSONAL INJURY OR DEATH AND/OR PROPERTY DAMAGE.

CAUTION

- All parts must be used as indicated in these instructions. Do not substitute any parts, leave parts out, or use any parts that are worn out or broken. Failure to follow this instruction could invalidate the ETL/CETL Listing of this fixture.
- When handling the fixture, do not apply pressure to the LEDs or bulbs. Hold the fixture by the base only.
- Do not exceed maximum wattage noted on the fixture. Use only the recommended LED or standard lamps with the fixture.

ADVERTENCIA

IMPORTANT: NUNCA trate de hacer ningún trabajo sin desconectar la electricidad.

- Lea todas las instrucciones antes de instalar.
- El sistema tiene por objeto la instalación de acuerdo con el Código Eléctrico Nacional, y otros códigos de instalación y reglamentos locales aplicables, por parte de un electricista autorizado que esté familiarizado con el funcionamiento del producto y los peligros involucrados.
- Vaya a la caja de fusibles o al panel de disyuntores principal. Ponga el interruptor principal de alimentación en la posición de "APAGADO", y desenrosque los fusibles o "DESCONECTE" los disyuntores que controlen la alimentación a los dispositivos o la habitación en los que usted está trabajando.
- Ponga el interruptor de pared en la posición de "APAGADO".
- EL HECHO DE NO INSTALAR ESTE DISPOSITIVO DE ACUERDO CON ESTAS INSTRUCCIONES PODRÍA RESULTAR EN UNA LESIÓN PERSONAL GRAVE O LA MUERTE, Y/O DAÑOS A LA PROPIEDAD.

PRECAUCIÓN

- Todas las piezas deben usarse como se indica en estas instrucciones. No sustituya ninguna pieza, no deje piezas fuera, ni utilice ninguna pieza que esté desgastada ni rota. El hecho de no seguir estas instrucciones podría invalidar la certificación ETL/CETL de este dispositivo.
- Al manipular el dispositivo, no aplique presión a los LED ni las bombillas. Sujete el dispositivo solo por la base.
- No exceda la potencia máxima indicada en el dispositivo. Use solo los LED o las bombillas estándar recomendados con el dispositivo.

ADVERTENCIA

IMPORTANT: NUNCA trate de hacer ningún trabajo sin desconectar la electricidad. IMPORTANT: Ne JAMAIS entreprendre des travaux sans couper l'électricité.

- Lire toutes les instructions avant l'installation.
- Ce système est conçu pour être installé conformément au Code national de l'électricité ou d'autres codes d'installation et réglementations locales en vigueur par un électricien agréé connaissant le fonctionnement de ce produit et les dangers qu'il comporte.
- Aller à la boîte à fusibles ou panneau principal de disjoncteurs. Placer l'interrupteur d'alimentation principal sur « ARRÊT » et dévisser le ou les fusibles ou mettre sur « ARRÊT » le ou les disjoncteurs qui contrôlent l'alimentation du ou des appareils électriques ou de la pièce dans laquelle vous travaillez.
- Mettre l'interrupteur mural sur « ARRÊT ».
- NÉGLIGER D'INSTALLER CET APPAREIL CONFORMÉMENT À CES INSTRUCTIONS RISQUE D'ENTRAÎNER DE GRAVES BLESSURES PERSONNELLES OU LA MORT AINSI QUE DES DOMMAGES MATÉRIELS.
- MISE EN GARDE
- Toutes les pièces doivent être utilisées comme indiqué dans ces instructions. Ne remplacer aucune pièce, ne laisser aucune pièce de côté ou n'utiliser aucune pièce usée ou cassée. Le non-respect de cette directive peut invalider l'homologation ETL/CETL de cet appareil.
- Lors de la manipulation de cet appareil, n'appliquer aucune pression sur les DEL ou les ampoules. Maintenir l'appareil par la base uniquement.
- Ne pas dépasser le nombre de watts maximum indiqué sur l'appareil. N'utiliser que les DEL ou ampoules standard recommandées dans cet appareil.

SCHONBEK
Beyond

Schonbek, 61 Industrial Blvd, Plattsburgh, New York, 12901

Phone: 1-800-836-1892 | Fax: 518-563-4228 |

www.schonbek.com

ASSEMBLY & INSTALLATION INSTRUCTIONS



Fixture
BWS27320

PREPARATION

1. Shut off the power at the circuit breaker and remove existing fixture, including the crossbar.
2. Carefully unpack your new fixture and lay out all the parts on a clear area. Be careful not to lose any small parts necessary for installation.

MOUNT ON 2x4" SWITCH BOX (Fig. 1)

3. Remove the mounting screws (B) from the mounting plate.
4. The lamp can switch between three color temperatures (3000K-3500K-4000K), which can be adjusted to your preference with the switch in the fixture (Fig.4).
5. Secure the mounting plate to the switch box using standard switch box screws that comes with the switch box.
Note: (i) It is recommended to use only original switch box screws or replacements provided by switch box manufacturer.
(ii) The side of the mounting plate marked "GND" must face out.
6. Connect the fixture input wires to the switch box wires (Fig. 1) using wire connectors (A) provided. Ensure all wire connectors are secure. Connect the fixture's ground wire to the ground in the switch box; this will be either a green wire or a bare copper wire. After fixture is wired to house wires, tuck wires carefully inside the switch box.
7. Secure the fixture to the mounting plate using the mounting screws (B).

MOUNT ON 4x4" JUNCTION BOX (Fig. 2)

3. Remove the mounting screws (B) from the mounting plate.
4. The lamp can switch between three color temperatures (3000K-3500K-4000K), which can be adjusted to your preference with the switch in the fixture (Fig.4).
5. Secure the mounting ring (D) to the junction box using the junction box screws.
Note: (i) It is recommended to use only original junction box screws or replacements provided by junction box manufacturer.
6. Secure the mounting plate and adapter plate (C) to the mounting ring (D) using adapter screws (E) as shown in Fig. 2.
Note: (i) The side of the mounting plate marked "GND" must face out, towards the installer.
7. Connect the input wires to the junction box wires (Fig. 2) using wire connectors (A) provided. Ensure all wire connectors are secure. Connect the fixture's ground wire to the ground in the junction box; this will be either a green wire or a bare copper wire. After fixture is wired to house wires, tuck wires carefully inside the junction box.
8. Secure the fixture to the mounting plate using the mounting screws (B).

HARDWARE

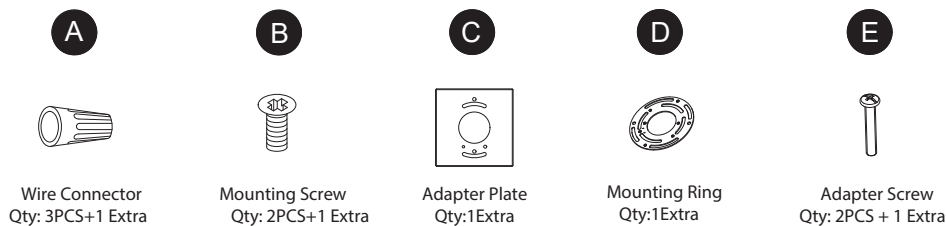

ASSEMBLY & INSTALLATION INSTRUCTIONS



Fixture
BWS27320

Fig. 1 Mount On Switch Box

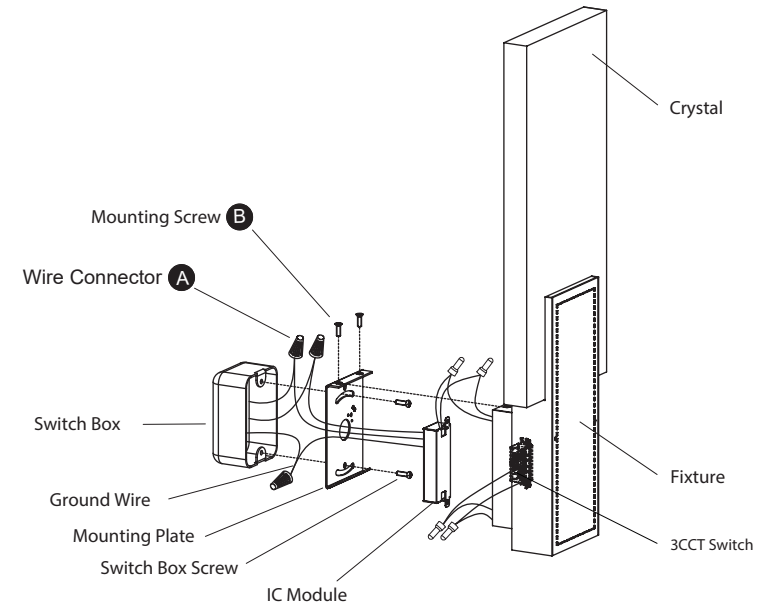

Fig. 2 Mount On Junction Box

