

SAFETY INFORMATION

Released Date: 2022-05-07

Please read and understand this entire manual before attempting to assemble, install or operate the product.

WARNING

• **RISK OF ELECTRIC SHOCK** - Before beginning installation, turn off electricity at the circuit breaker box or the main fuse box.

• **CAUTION**

• For your safety, read instructions completely before beginning installation.
• If in doubt about electrical installation, consult a licensed electrician.

• **TOOLS REQUIRED**

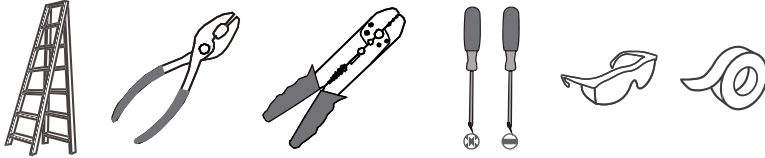

Ratings	120Vac, 60Hz	
	Model No.	Wattage
	WLB8605BN	8W
	WLB8605C	8W
	WLB8605MBK	8W
	WLB8605Y	8W

CARE AND MAINTENANCE

• Wipe clean using soft, dry cloth or static duster. Always avoid using harsh chemicals and abrasives to clean fixture as they may damage the finish.

If you need further assistance call Quozel Customer Care at 1-800-645-3184 (9:00am - 5:00pm EST), or visit us on-line at www.quezel.com.

PACKAGE CONTENTS

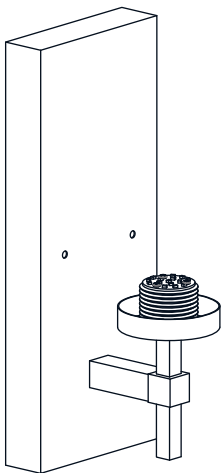

A Fixture Body
x 1

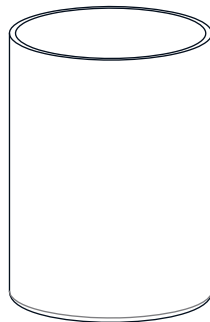

B Glass Shade
x 1

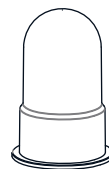

C Glass Holder
[pre-assembled to
Fixture Body]
x 1

MOUNTING HARDWARE

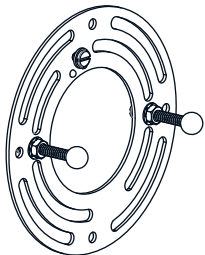

AA Crossbar Assembly
x 1

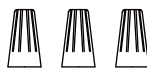

BB Wire Connector
x 3



CC Outlet Box Screw
x 2

INSTALLATION

1 Install Crossbar Assembly

Outlet Box

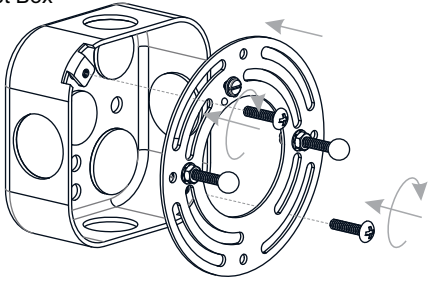

2 Wiring

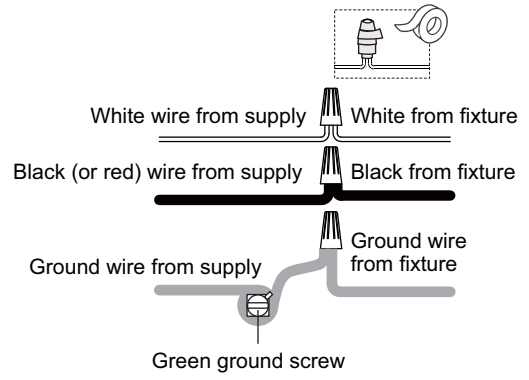

3 Install Fixture Body

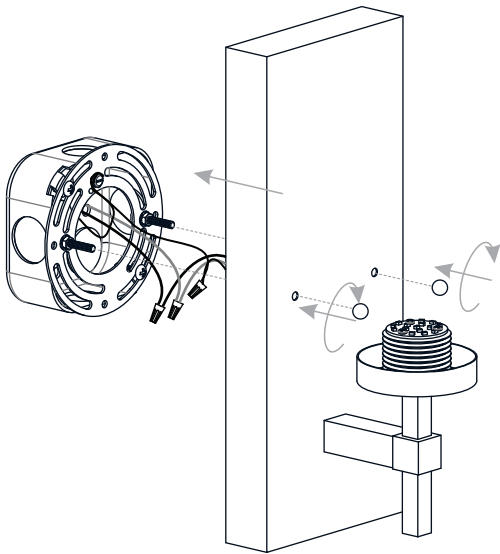

4 Install Glass Shade

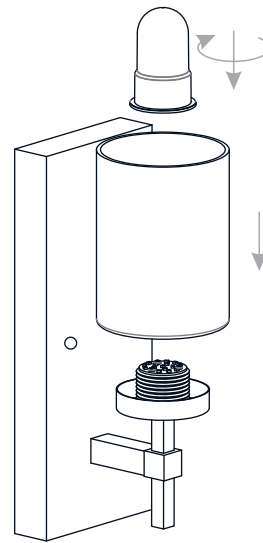

Your installation is now complete! Restore electricity and save this sheet for future reference.