

Please go to [www. quozel. com](http://www. quozel. com) for product cleaning tips. Go to the **Care + Maintenance** selection.

**Tools Required:** Flathead screwdriver, Phillips screwdriver, pliers, wire cutters, wire strippers, electrical tape, safety glasses.

**Light Source:** Integrated LED 15W

**Compatible Dimmer Switches:** Lutron AYCL-153P or Lutron DVCL-153P.

**Estimated Assembly Time:** 20-30 minutes

**Preparation:** Identify and inspect all parts before beginning installation. Check package content list and diagrams below to be sure all parts are present. If any parts are missing or damaged, do not attempt to assemble, install, or operate the fixture. Contact customer service for replacement parts.

### **⚠ Warnings and Cautions**

Turn off electricity at circuit breaker or main fuse box before installation. Consult a licensed electrician if in doubt.

These instructions are provided for your safety. It is very important you read them completely before installing the fixture. We strongly recommend that a licensed, professional electrician perform the installation.

### Package Contents

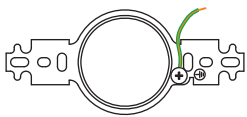

**A** Mounting Plate  
x 1

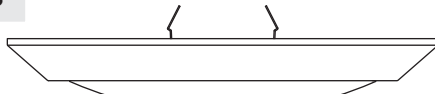

**B** Fixture Body  
x 1

### STEP 1 - Install Mounting Plate

- A. Attach the Mounting Plate (A) to outlet box with the head of green ground screw against outlet box. Connect ground wire from Mounting Plate (A) to bare or green ground wire from outlet box with one wire connectors. Wrap the connection with approved electrical tape.
- B. Pass supply wires through the Mounting Plate (A). Attach the Mounting Plate (A) to outlet box and secure it with outlet box screws (not included). Tighten until snug with screwdrivers.

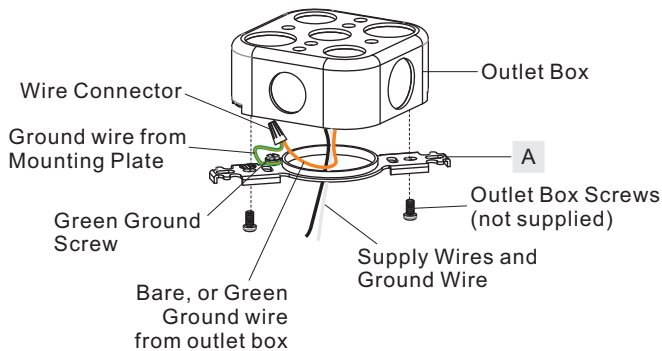

Figure 1

### STEP 2 - Wire Connections

- A. Use standard wire connectors (not included) to make all wire connections. Twist connectors until wires are tightly joined together. Wrap each connection with approved electrical tape and carefully stuff all the connected wires into the Outlet Box.

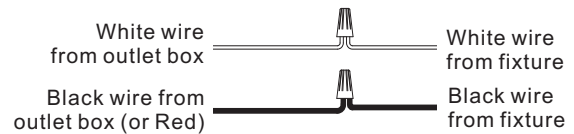

Figure 2

### STEP 3 - Install Fixture Body

- A. Carefully tuck all wires into the outlet box and push mounting clips on Fixture Body (B) into Mounting Plate (A).

Your fixture is now assembled and ready to use. Enjoy!

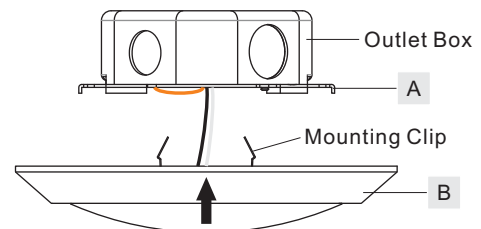
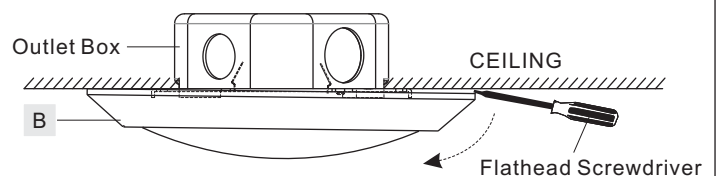

Figure 3

### HOW TO REMOVE FIXTURE BODY AFTER INSTALLATION

If you want to remove the Fixture Body (B) from the ceiling after assembly, use the Flathead Screwdriver to lever the Fixture Body (B) and carefully remove it with hands.



**Thank you for purchasing a Quoizel product.**  
**Need assistance with parts or assembly? Call Quoizel customer service at 1-800-645-3184**  
**or visit us on-line at [www. quozel. com](http://www. quozel. com)**

VRG1608W

FINISH: FRESCO

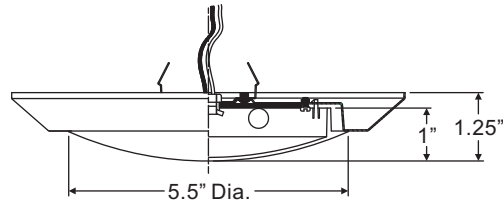
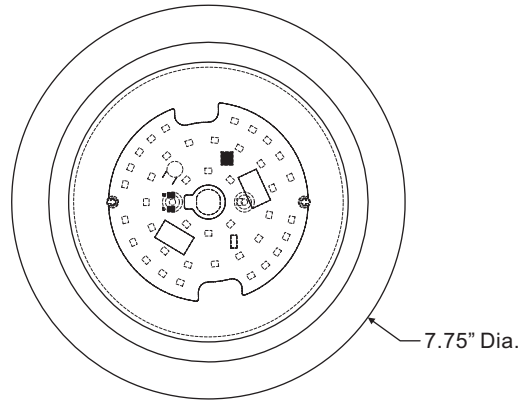
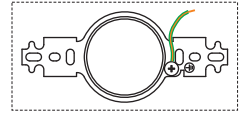

NOTE: ALL DIMENSIONS ARE ROUNDED UP TO THE NEAREST 1/4"

Thank you for purchasing a Quoizel product.  
Need assistance with parts or assembly? Call Quoizel customer service at 1-800-645-3184  
or visit us on-line at [www.quoizel.com](http://www.quoizel.com)