

## SAFETY INFORMATION

Please read and understand this entire manual before attempting to assemble, install or operate the product.

### WARNING

- RISK OF ELECTRIC SHOCK - Before beginning installation, turn off electricity at the circuit breaker box or the main fuse box.
- RISK OF FIRE - Use bulbs specified by the markings and/or labels on the fixture.

### CAUTION

- For your safety, read instructions completely before beginning installation.
- If in doubt about electrical installation, consult a licensed electrician.
- Turn off electricity to fixture before replacing the bulb(s).

### TOOLS REQUIRED

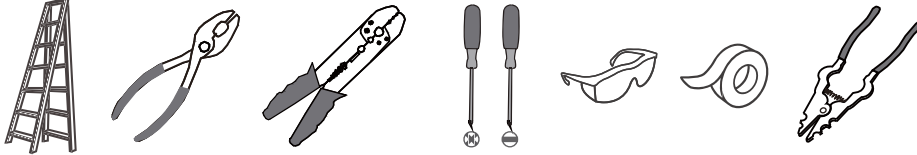

## CARE AND MAINTENANCE

- Wipe clean using soft, dry cloth or static duster. Always avoid using harsh chemicals and abrasives to clean fixture as they may damage the finish.

If you need further assistance call Quozel Customer Care at 1-800-645-3184 (9:00am - 5:00pm EST), or visit us on-line at [www.quozel.com](http://www.quozel.com).

## PACKAGE CONTENTS

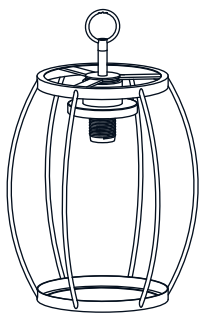

**A** Fixture Body  
x 1

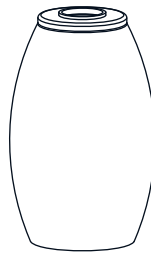

**B** Shade  
x 1



**C** Socket Collar  
(pre-assembled to  
Fixture Body)  
x 1

## MOUNTING HARDWARE

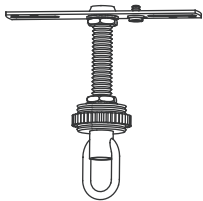

**AA** Crossbar Assembly  
x 1

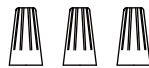

**BB** Wire Connector  
x 3



**CC** Outlet Box Screw  
x 2

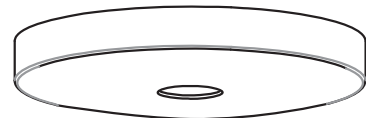

**DD** Ceiling Canopy  
x 1

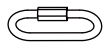

**EE** Quick Link  
x 2



**FF** Fixture Chain  
x 1

# INSTALLATION

## 1 Install Crossbar Assembly

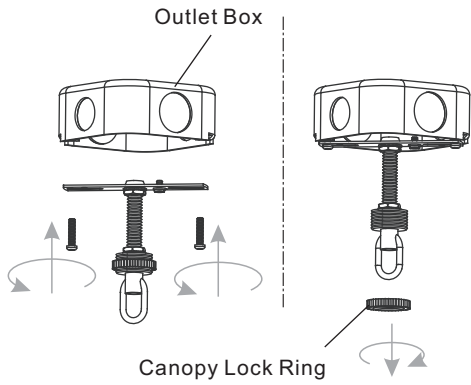

## 2 Install Fixture Chain

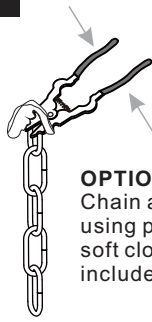

**OPTIONAL:** Adjust Chain as desired, using pliers and soft cloth (neither included).

Suggested chain length for Ceiling height:  
8 feet ceiling: use 5 links of chain and 2 quick links  
9 feet ceiling: use 15 links of chain and 2 quick links  
10 feet ceiling: use 25 links of chain and 2 quick links.

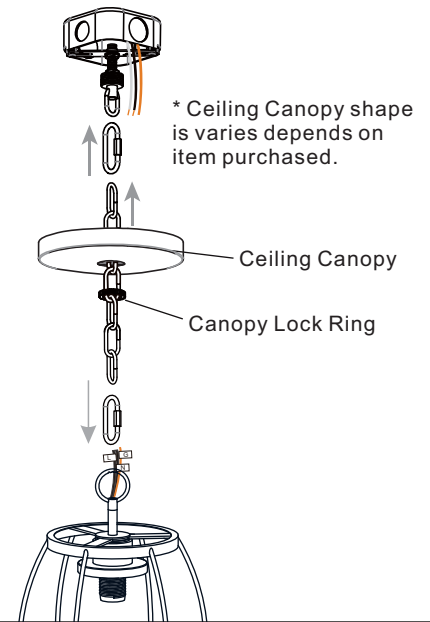

## 3 Pull Supply Wires

Pull the supply wires with ground wire through the chain alternate links.

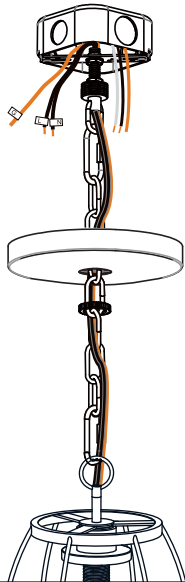

## 4 Wiring

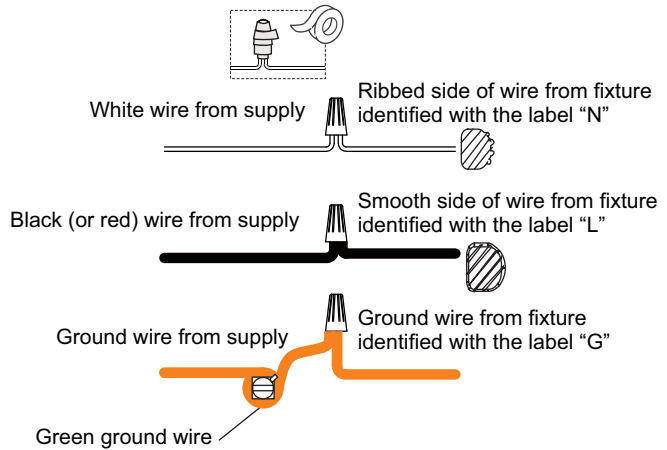

## 5 Install Ceiling Canopy

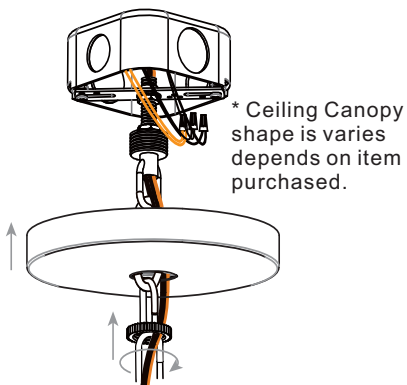

## 6 Install Shade and Bulb

Install one correct bulb referring to fixture markings and/or labels for maximum wattage.

**Recommended Bulb Type (not included):**

  
BULB BASE TYPE  
Medium (E26)

  
BULB TYPE  
TYPE A

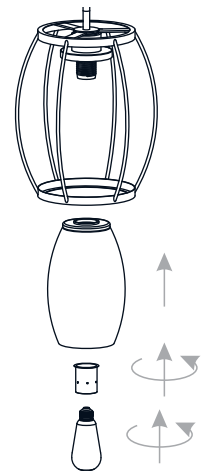

Your installation is now complete! Restore electricity and save this sheet for future reference.