

Please go to www.quirrel.com for product cleaning tips. Go to the **Care + Maintenance** selection.

Tools Required: Flathead screwdriver, Phillips screwdriver, pliers, wire cutters, wire strippers, electrical tape, safety glasses.

Light Source: (1) A19 Medium Base Bulb 100W Maximum, Medium Base Vintage Bulb is recommended, bulb not included.

Fixture Hanging Height: Minimum Hanging Height is 13.75", Maximum Hanging Height is 51.25".

Estimated Assembly Time: 30-45 minutes

Preparation: Identify and inspect all parts before beginning installation. Check package content list and diagrams below to be sure all parts are present. If any parts are missing or damaged, do not attempt to assemble, install, or operate the fixture. Contact your original place of purchase.

Note: This CONVERTIBLE fixture can be mounted as mini-pendant light or semi-flush light. Refer to respective installation steps for installations.

⚠ Warnings and Cautions

Turn off electricity at circuit breaker or main fuse box before installation. Consult a licensed electrician if in doubt.

These instructions are provided for your safety. It is very important you read them completely before installing the fixture. We strongly recommend that a licensed, professional electrician perform the installation.

Disconnect fixture from power source before replacing bulbs. Make sure bulbs are given sufficient time to cool before removal.

Package Contents

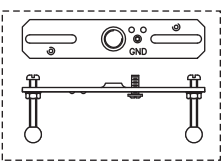

A Crossbar Assembly x 1

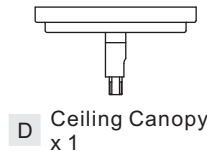
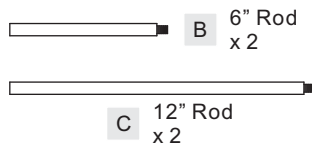

D Ceiling Canopy x 1

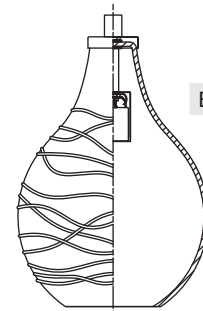

E Fixture Body x 1

Assembly Instructions for Mini-Pendant Light (Step 1A - Step 7A)

STEP 1A - Tighten the Hex Nut inside of the Ceiling Canopy

- A. By using pliers, tighten the hex nut inside of the Ceiling Canopy (D) to secure the swivel.

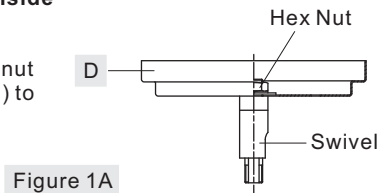

Figure 1A

STEP 2A - Install Ceiling Canopy, Rods and Fixture Body together

- A. Determine the Rods (B/C) to be assembled to the Fixture Body (E) according to your hanging height.
B. Pass the supply wires and ground wire through the chosen rods (B/C) and the Ceiling Canopy (D). Thread the Fixture Body (E), the chosen Rods (B/C) and the Ceiling Canopy (D) together. Hand tighten until snug.

Suggested rods for Ceiling height :
8' ceiling : use (2) 12" rods
9' ceiling : use (2) 6" rods and (2) 12" rods

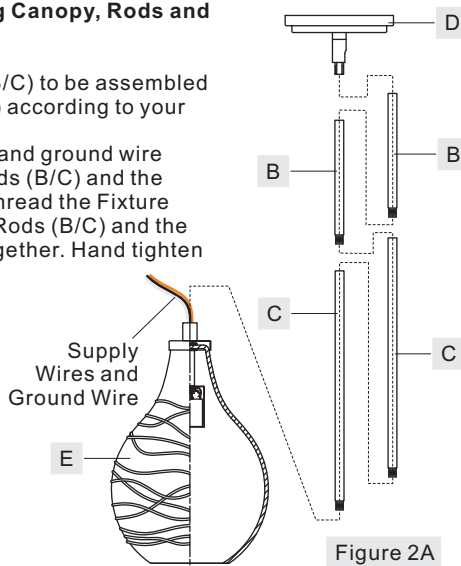

Figure 2A

STEP 3A - Installing the Crossbar Assembly

- A. Pass the supply wires from outlet box through the Crossbar Assembly (A). Attach the Crossbar Assembly (A) to the Outlet Box with the head of the Green Ground Screw facing you. Secure the Crossbar Assembly (A) with Outlet Box Screws (not included). Tighten until snug.

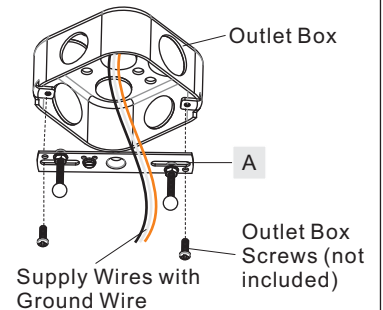

Figure 3A

STEP 4A - Test Fitting Ceiling Canopy to Crossbar Assembly

- A. Remove mounting balls from the Crossbar Assembly (A). Fit the Ceiling Canopy (D) to the Crossbar Assembly (A) and secure with mounting balls. Note: The Ceiling Canopy (D) should be snug against the ceiling and the mounting balls. If not, adjust the length of the nipple on the Crossbar Assembly (A) by unscrewing the preassembled hex nut and lock washer and then screwing the mounting screws in or out of the crossbar until the correct length is achieved. Once the Ceiling Canopy (D) is secure, remove the mounting ball and Ceiling Canopy (D).

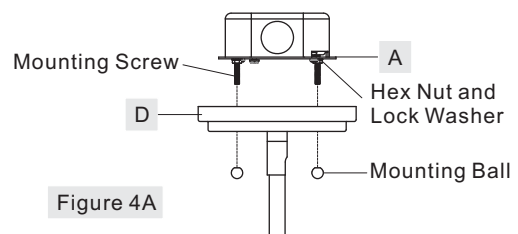
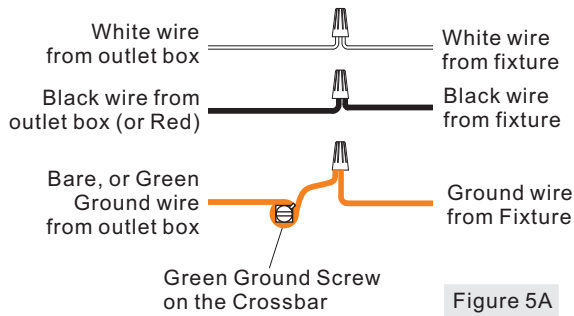

Figure 4A

STEP 5A - Wire Connections

- Wrap bare or green ground wire around green ground screw on the crossbar, no less than 2 inches from the end of the wire. Tighten the green ground screw.
- Use standard wire connectors (not included) to make all wire connections. Twist connectors until wires are tightly joined together. Wrap each connection with approved electrical tape and carefully stuff all the connected wires into the Outlet Box.



STEP 6A - Install the Fixture

- Carefully tuck all wires into the outlet box and position the Ceiling Canopy (D) over the outlet box. Align the holes in the Ceiling Canopy (D) with the mounting screws, then attach the Ceiling Canopy (D) using the previously removed mounting balls. Hand tighten until snug.

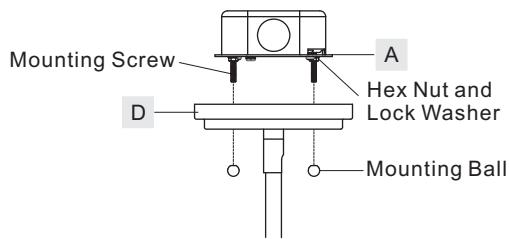

STEP 7A - Install Bulb

- Insert the bulb onto socket and screw snugly into place.

Your fixture is now assembled and ready to use. Enjoy!

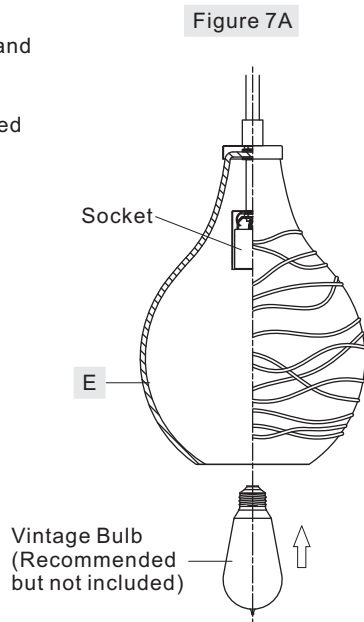

Assembly Instructions for Semi-flush Light (Step 1B - Step 2B)

Part B and Part C will not be used in the assembly of the Semi-Flush Light fixture. Please set aside these parts.

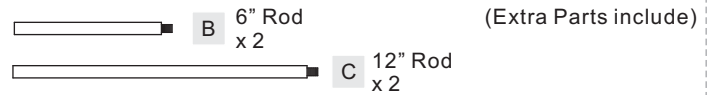

STEP 1B - Separate Swivel from Ceiling Canopy

- Unscrew the hex nut and remove the swivel from the ceiling canopy.
- Remove the nipple from the swivel.
- Set the swivel aside since it is not necessary for the following installations.

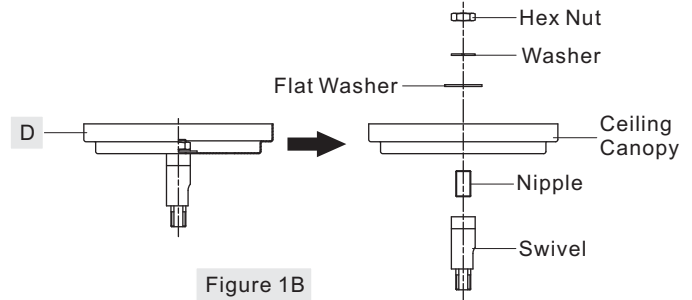

STEP 2B - Install Ceiling Canopy to Fixture Body

- Thread the removed nipple in Step 1B onto the Fixture Body (E) and hand tighten until snug.
- Place the ceiling canopy, flat washer and washer onto the nipple in turn. Secure with previously removed hex nut. Tighten until snug.
- Go to Step 3A - Step 7A to complete installations.

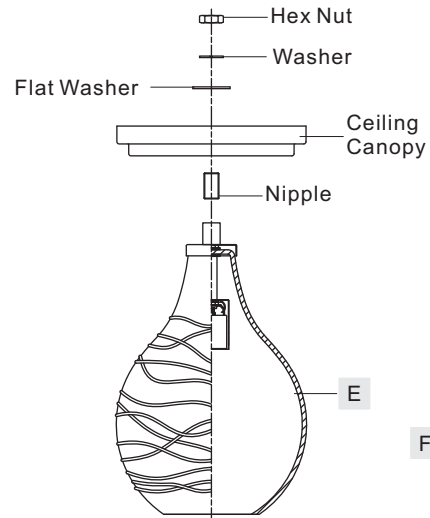

QPP4019BN

FINISH: BRUSHED NICKEL

NOTE: ALL DIMENSIONS ARE ROUNDED UP TO THE NEAREST 1/4"

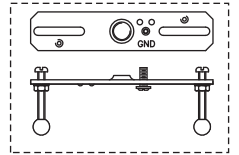

MINI-PENDANT LIGHT

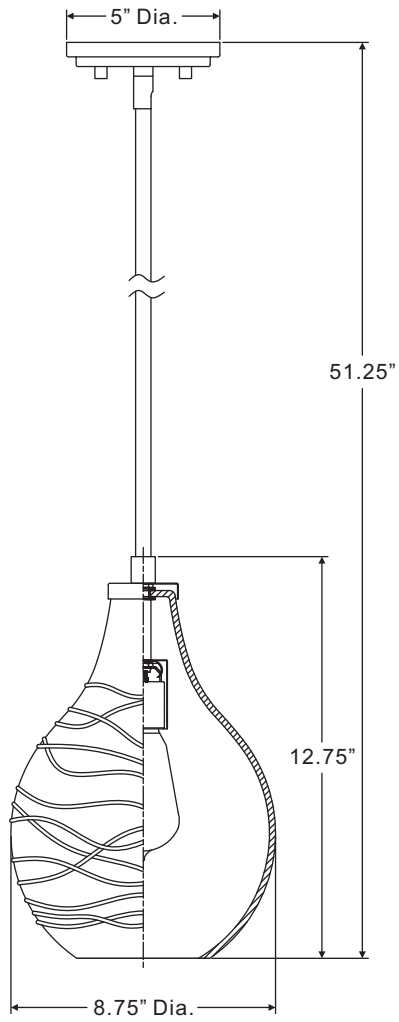
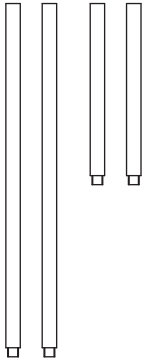

SEMI-FLUSH LIGHT

