

SAFETY INFORMATION

Please read and understand this entire manual before attempting to assemble, install or operate the product.

WARNING

- RISK OF ELECTRIC SHOCK - Before beginning installation, turn off electricity at the circuit breaker box or the main fuse box.
- RISK OF FIRE - Use bulbs specified by the markings and/or labels on the fixture.

CAUTION

- For your safety, read instructions completely before beginning installation.
- If in doubt about electrical installation, consult a licensed electrician.
- Turn off electricity to fixture before replacing the bulb(s).

TOOLS REQUIRED

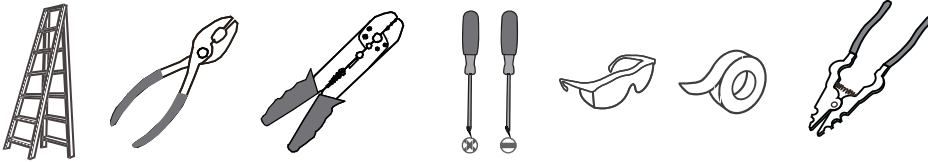

CARE AND MAINTENANCE

- Wipe clean using soft, dry cloth or static duster. Always avoid using harsh chemicals and abrasives to clean fixture as they may damage the finish.

If you need further assistance call Quoizel Customer Care at 1-800-645-3184(9:00am - 5:00pm EST), or visit us on-line at www.quoizel.com

PACKAGE CONTENTS

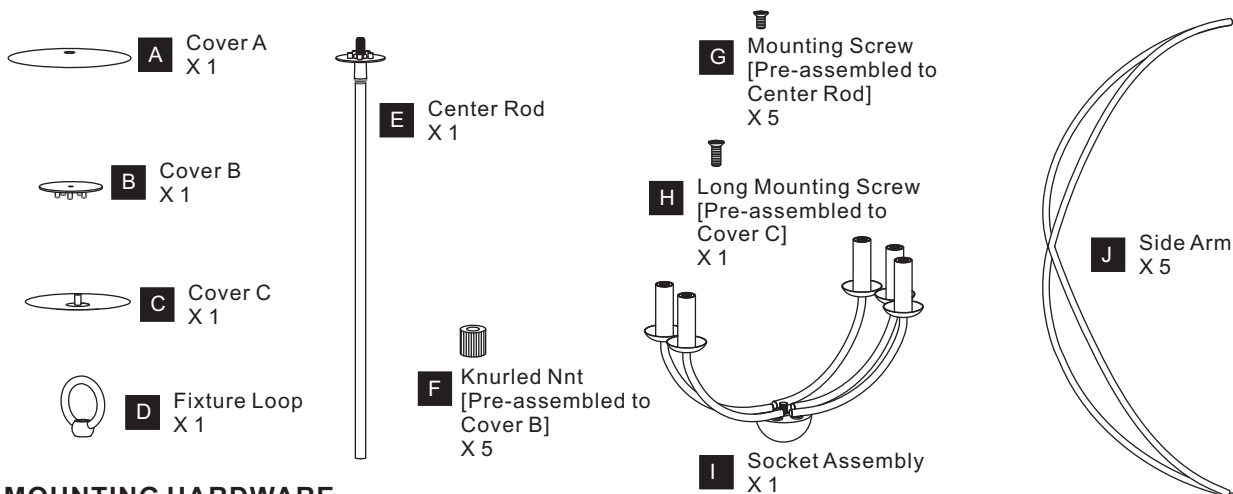

MOUNTING HARDWARE

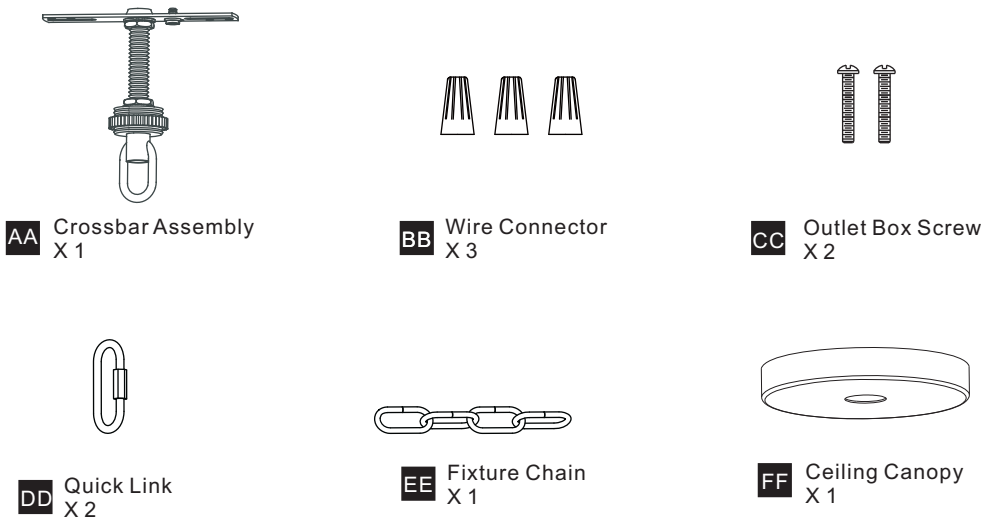

INSTALLATION

1 Unfold Arms

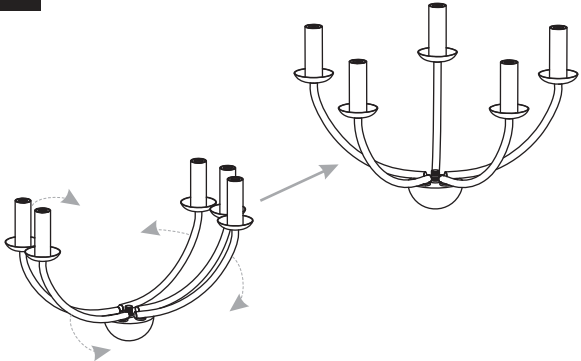

2 Install Socket Assembly

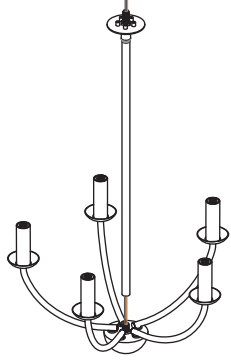

3 Pull Side Arms

* Line up labels "A" on Center rod and side arms during assembly.

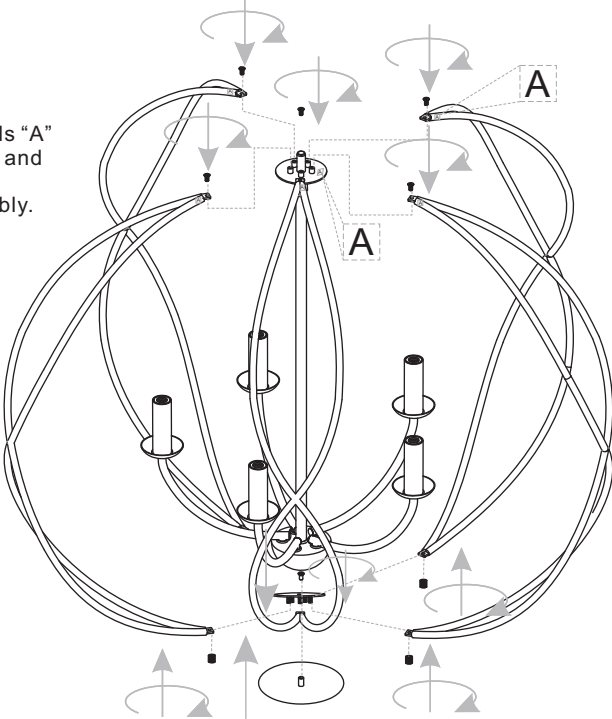

4 Pull Cover A to Fixture Loop

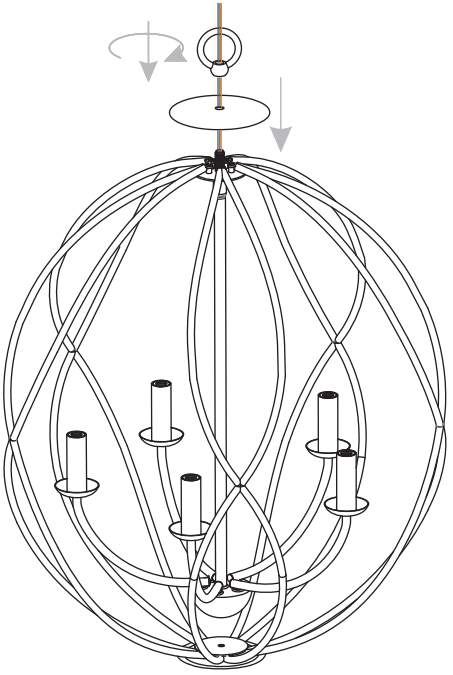

5 Install Crossbar Assembly

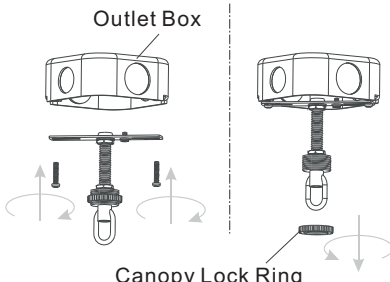

Outlet Box

Canopy Lock Ring

6 Install Fixture Chain

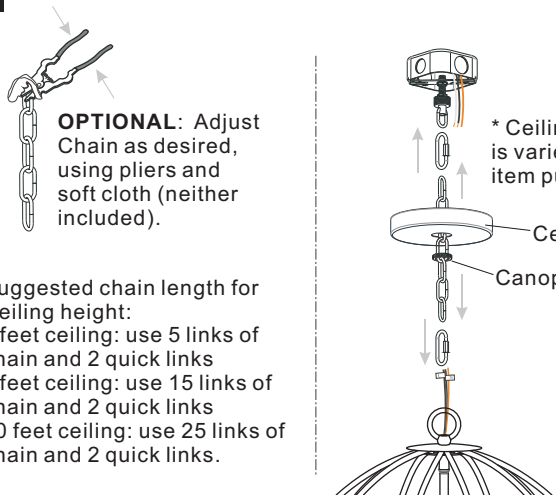

OPTIONAL: Adjust Chain as desired, using pliers and soft cloth (neither included).

Suggested chain length for Ceiling height:
8 feet ceiling: use 5 links of chain and 2 quick links
9 feet ceiling: use 15 links of chain and 2 quick links
10 feet ceiling: use 25 links of chain and 2 quick links.

* Ceiling Canopy shape is varies depends on item purchased.

Ceiling Canopy

Canopy Lock Ring

INSTALLATION

7 Pull Supply Wires

Pull the supply wires with ground wire through the chain alternate links.

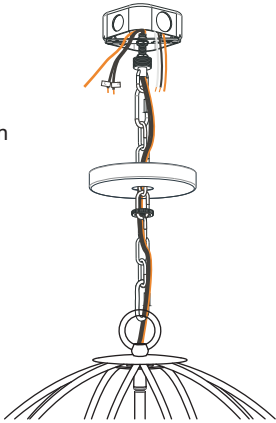

8 Wiring

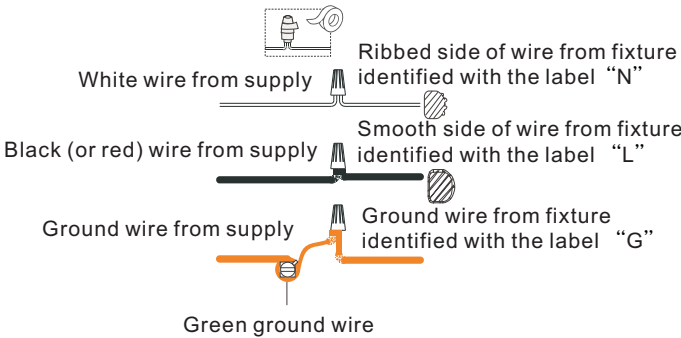

White wire from supply

Black (or red) wire from supply

Ground wire from supply

Ribbed side of wire from fixture identified with the label "N"

Smooth side of wire from fixture identified with the label "L"

Ground wire from fixture identified with the label "G"

Green ground wire

9 Install Ceiling Canopy

* Ceiling Canopy shape is varies depends on item purchased.

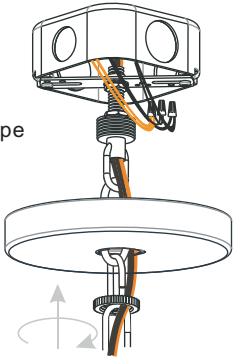

10 Install Bulbs

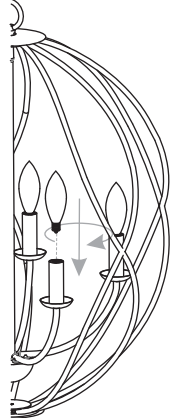

Install five correct bulbs referring to fixture markings and/or labels for maximum wattage.

Recommended Bulb Type (not included):

BULB BASE TYPE	BULB SHAPE TYPE
Candelabra (E12)	TYPE B

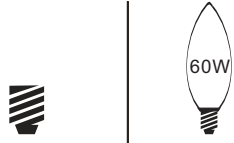

Your installation is now complete! Restore electricity and save this sheet for future reference.