

Please go to www.quirrel.com for product cleaning tips. Go to the **Care + Maintenance** selection.

Tools Required: Flathead screwdriver, Phillips screwdriver, pliers, wire cutters, wire strippers, electrical tape, safety glasses.

Light Source: (6) B10 Candelabra Base bulbs 60W Maximum, bulb not included.

Fixture Hanging Height: Minimum Hanging Height is 13.5", Maximum Hanging Height is 53.5".

Estimated Assembly Time: 30-45 minutes

Preparation: Identify and inspect all parts before beginning installation. Check package content list and diagrams below to ensure all parts are present. If any parts are missing or damaged, do not attempt to assemble, install, or operate the fixture. Contact your original place of purchase.

Note: This CONVERTIBLE fixture can be mounted as pendant light or semi-flush light. Refer to respective installation steps for installations.

⚠ Warnings and Cautions

Turn off electricity at circuit breaker or main fuse box before installation. Consult a licensed electrician if in doubt.

These instructions are provided for your safety. It is very important you read them completely before installing the fixture. We strongly recommend that a licensed, professional electrician perform the installation.

Disconnect fixture from power source before replacing bulbs. Make sure bulbs are given sufficient time to cool before removal.

Package Contents

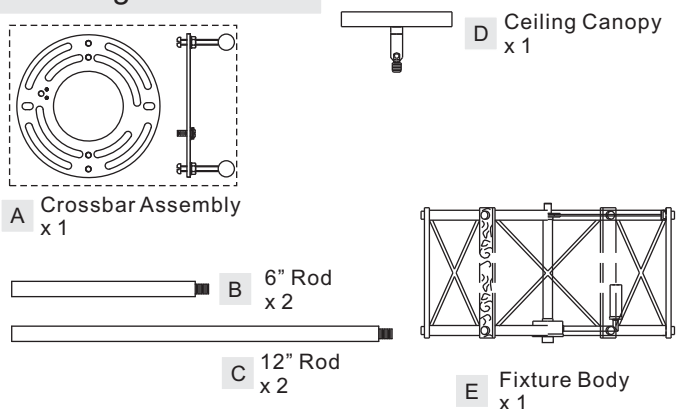

STEP 2A – Installing the Crossbar Assembly

A. Pass the supply wires from outlet box through the Crossbar Assembly (A). Attach the Crossbar Assembly (A) to the Outlet Box with the head of the Green Ground Screw facing you. Secure the Crossbar Assembly (A) with Outlet Box Screws (not included). Tighten until snug.

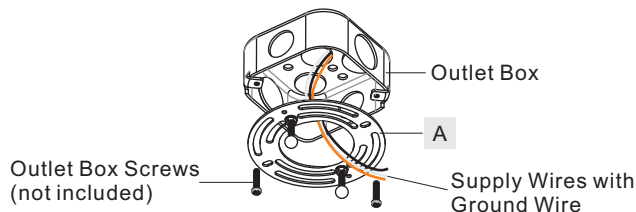

Figure 2A

Assembly Instructions for Pendant Light: BRO2820MK (Step 1A - Step 6A)

STEP 1A - Install Ceiling Canopy, Rods and Fixture Body together

- Determine the Rods (B/C) to be assembled to the Fixture Body (E) according to your hanging height.
- Pass the supply wires and ground wire through the chosen rods (B/C) and the Ceiling Canopy (D). Thread the Fixture Body (E), the chosen Rods (B/C) and the Ceiling Canopy (D) together. Hand tighten until snug.

Suggested rods for Ceiling height :
 8' ceiling : use (1) 6" rods and (1) 12" rods
 9' ceiling : use (1) 6" rods and (2) 12" rods

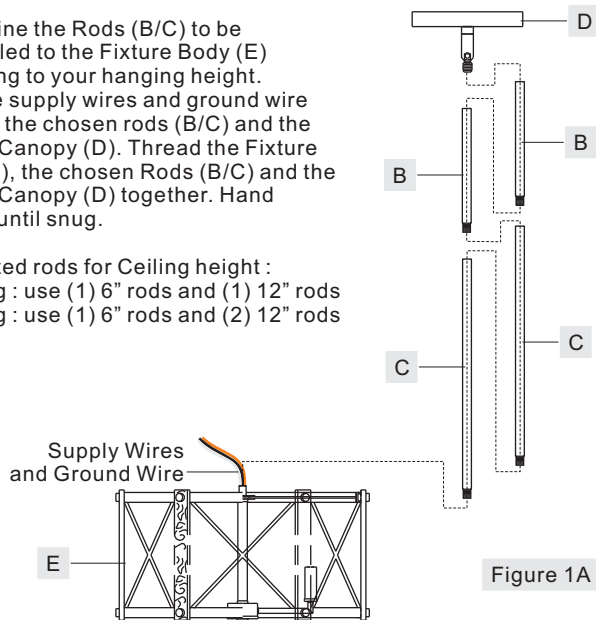

Figure 1A

STEP 3A – Test Fitting Ceiling Canopy to Crossbar Assembly

A. Remove mounting balls from the Crossbar Assembly (A). Fit the Ceiling Canopy (D) to the Crossbar Assembly (A) and secure with mounting balls. Note: The Ceiling Canopy (D) should be snug against the ceiling and the mounting balls. If not, adjust the length of the nipple on the Crossbar Assembly (A) by unscrewing the preassembled hex nut and lock washer and then screwing the mounting screws in or out of the crossbar until the correct length is achieved. Once the Ceiling Canopy (D) is secure, remove the mounting ball and Ceiling Canopy (D) and proceed to Step 4A.

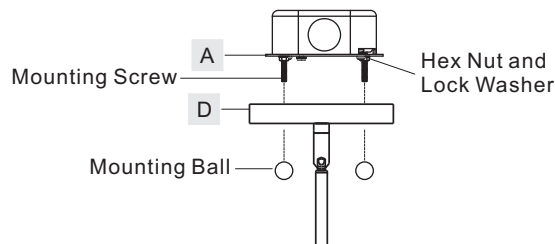
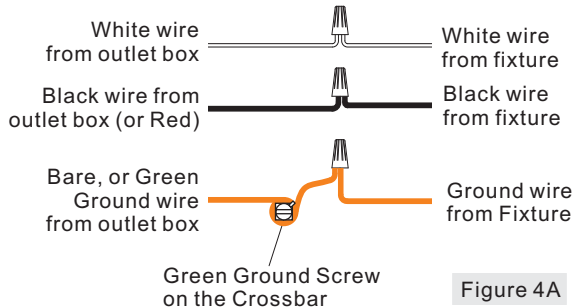

Figure 3A

STEP 4A - Wire Connections

- A. Wrap bare or green ground wire around green ground screw on the crossbar, no less than 2 inches from the end of the wire. Tighten the green ground screw.
- B. Use standard wire connectors (not included) to make all wire connections. Twist connectors until wires are tightly joined together. Wrap each connection with approved electrical tape and carefully stuff all the connected wires into the Outlet Box.



STEP 5A - Install the Fixture

- A. Carefully tuck all wires into the outlet box and position the Ceiling Canopy (D) over the outlet box. Align the holes in the ceiling canopy with the mounting screws, then attach the Ceiling Canopy (D) using the previously removed mounting balls. Hand tighten until snug.

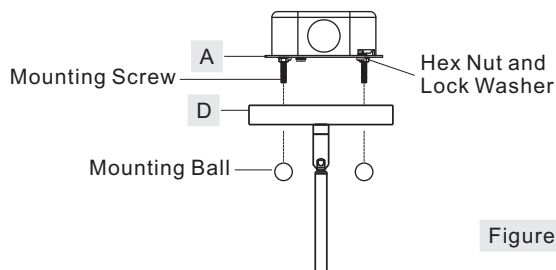

STEP 6A - Install Bulbs

- A. Insert bulbs onto sockets and screw snugly into place.
- Your fixture is now assembled and ready to use. Enjoy!

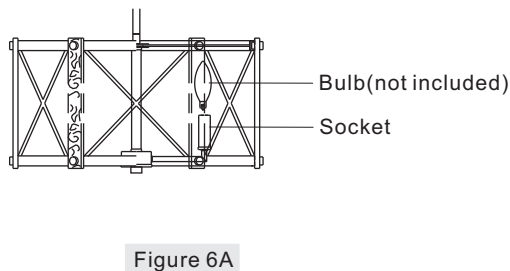

Assembly Instructions for Semi-Flush Light: BRO1720MK (Step 1B)

The following parts will not be used in the assembly of the Semi-Flush Light fixture. Please set aside these parts.

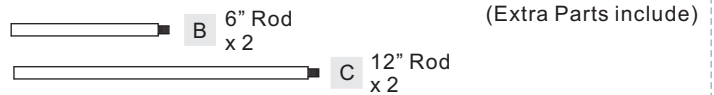

STEP 1 - Install Ceiling Canopy and Fixture Body together

- A. Pass the supply wires and ground wire through the Ceiling Canopy (D). Thread the Fixture Body (E) and the Ceiling Canopy (D) together. Hand tighten until snug. Cut the wires leaving approximately 6" of wire extending from the ceiling canopy.
- B. Go to Step 2A - Step 6A to complete installations.

