

INSTALLATION INSTRUCTION for 5423

For Wall Mount Light Fixtures

**WARNING! SHUT POWER OFF AT FUSE OR CIRCUIT BREAKER .
AVERTISSEMENT! COUPER LE COURANT AU NIVEAU DES FUSIBLES OU DU DISJONCTEUR.**

PREPARATION

1. Shut off the power at the circuit breaker and remove the old fixture, including the mounting hardware.
2. Carefully remove the fixture from the carton and check that all parts are included as shown in the illustration.

MOUNTING THE FIXTURE (Fig.1)

3. Position the hanging bracket (E) on the wall and mark the location for the drywall anchors (A). Pre-drill the holes for the drywall anchors (A) (Size: 067-1) and insert them into the wall.
4. Attach the hanging bracket (E) to the outlet box using the junction box screws (D) (Size: #8-32*0.6"L). The side of the hanging bracket marked "GND" must face out.
5. Place the wood screws (B) (Size: 8#x1"L) through the mounting plate and into the drywall anchors (A) to secure the hanging bracket (E) to the wall.
6. Secure mounting screw (C) (Size: #8-32*0.87"L) into the slotted holes.

CONNECTING THE WIRES (Fig. 2)

7. At this point, connect the electrical wires as shown in Fig. 2, making sure that all wire connectors are secured. If your outlet box has a ground wire (green or bare copper), connect the fixture's ground wire to it. Otherwise, connect the fixture's ground wire directly to the mounting plate using the green screw provided. After the wires are connected, tuck them carefully inside the outlet box.

COMPLETING THE INSTALLATION (Fig. 1)

8. Place the fixture body (I) over the hanging bracket (E), allowing the mounting screws (C) (Size: #8-32*0.87"L) to protrude through the hanging bracket (E) and secure it with the finials (J).
9. Place the glass (G) over the socket (H) and secure the glass (G) with the socket ring (F).
10. Install the light bulb(s) in accordance with the fixture's specifications (**DO NOT EXCEED THE SPECIFIED WATTAGE!**) (**NE PAS DEPASSER LA PUISSANCE NOMINALE MAXIMALE!**).

Your installation is now complete. Return power to the junction box and test the fixture.

Note: Illustration (Fig.1) on this manual is for installation purposes only. It may or may not be identical to the fixture purchased.

Fig.1

Set# A-020-480108

- Hanging bracket
- Ground screw
- Mounting screw*2
- Junction box screws*2
- Wood screws*2
- Anchors*2

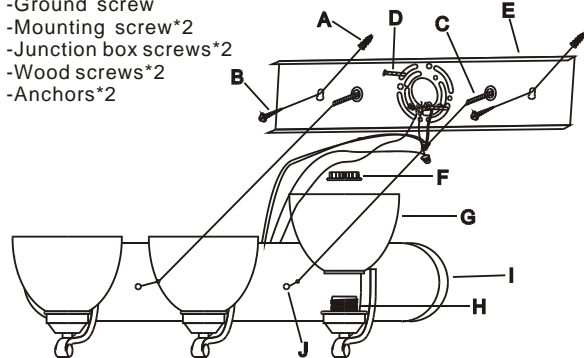

Fig.2

