

#### Features

- 36" minimum base cabinet width.
- Single bowl.
- 5-1/4" depth.
- Basin slopes toward drain to minimize water pooling.
- Offset drain increases workspace in the sink and storage space underneath.

#### Material

- KOHLER® enameled cast iron.

#### Installation

- Top-mount.

#### Recommended Products/Accessories

- K-6237 Left-Bowl Sink Rack
- K-6255 Right-Bowl Sink Rack
- K-8801 Sink drain and strainer with tailpiece
- K-8799 Sink drain and strainer basket
- K-23726 Drain treatment
- K-23725 Cast iron cleaner

#### Optional Products/Accessories

- K-11352 Disposal Flange with Stopper
- K-9000 P-Trap



ADA

#### Codes/Standards









ASME A112.19.1/CSA B45.2  
ADA  
ICC/ANSI A117.1

#### KOHLER® Enameled Cast Iron Kitchen Sink Lifetime Limited Warranty

See website for detailed warranty information.

#### Available Colors/Finishes

*Color tiles intended for reference only.*

Color	Code	Description
	0	White
	FF	Sea Salt™
	96	Biscuit
	47	Almond
	95	Ice™ Grey
	G9	Sandbar
	K4	Cashmere
	7	Black Black™

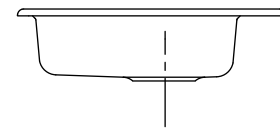
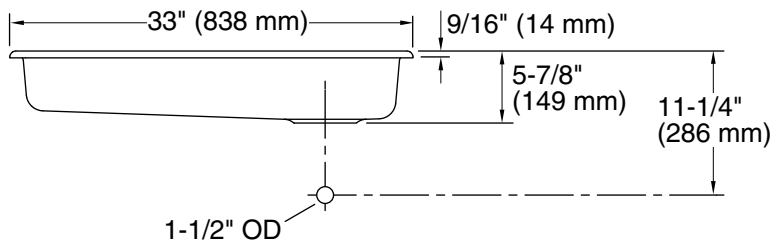
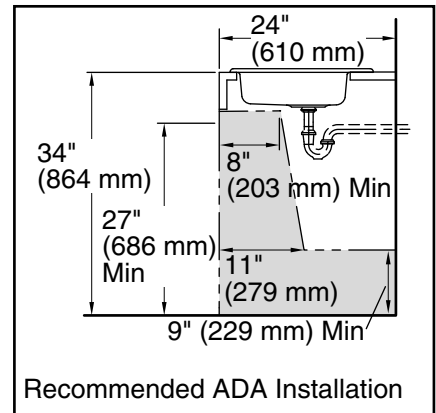
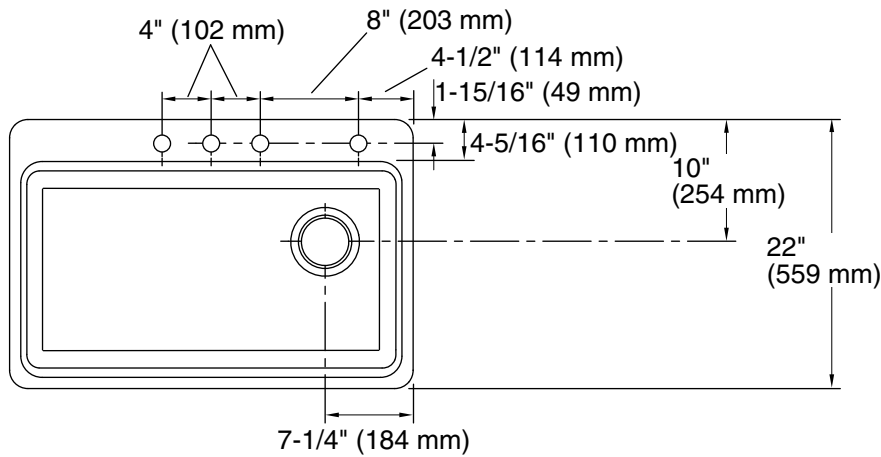

### Technical Information

All product dimensions are nominal.

Bowl configuration: Single

Installation: Top-mount

Min. base cabinet width: 33" (838 mm)

Bowl area (Only):  
 Length: 30-1/4" (769 mm)  
 Width: 17-1/4" (438 mm)  
 Bowl depth: 5-1/4" (133 mm)  
 Water depth: 5-1/4" (133 mm)

Faucet hole spacing: 4" (102 mm)

Template: 1166727-7, required, included

### Notes

Install this product according to the installation instructions.

ADA compliant when installed to the specific requirements of these regulations.