

Features

- Frameless design emphasizes glass and creates a sleek, minimalist look.
- Vertical handle with inside knob on moving panel.
- Gently-curved towel bar provides integrated storage on fixed panel.
- Tempered glass ensures maximum safety and durability.
- CleanCoat® technology creates a protective barrier that repels water, prevents dirt and minerals from collecting, and makes it easier to remove hard water spots.
- Smooth, easy-to-clean wall jambs.
- Full-length moving panel seal provides excellent water containment.
- Upgrade to heavy 5/16" (8 mm) thick glass and tall height shower door by selecting K-707615-8G81.
- Coordinates with other items in the Elate collection.

Material

- Frameless, 1/4" (6 mm) thick Frosted tempered glass.
- Anodized aluminum prevents rust and corrosion.

Installation

- Fits opening widths 56-1/4" - 59-5/8" (1429 - 1514 mm).
- 70-1/2" (1791 mm) high, with 67-11/16" (1719 mm) walk-through height.
- 3-3/8" (86 mm) width adjustment.
- Out-of-plumb adjustability simplifies installation.
- Door can be installed to open to the left or right to suit your bathroom layout.
- For residential use only.
- Not for use in hospitality.

Recommended Products/Accessories

K-23723 Faucet cleaner



Codes/Standards

ANSI Z97.1
CPSC 16CFR 1201

KOHLER® One-Year Limited Warranty

See website for detailed warranty information.

Available Colors/Finishes

Color tiles intended for reference only.

Color	Code	Description
	SH	Bright Silver
	MX	Matte Nickel
	BL	Matte Black

Available Glass Options

Code	Description
D3	Frosted

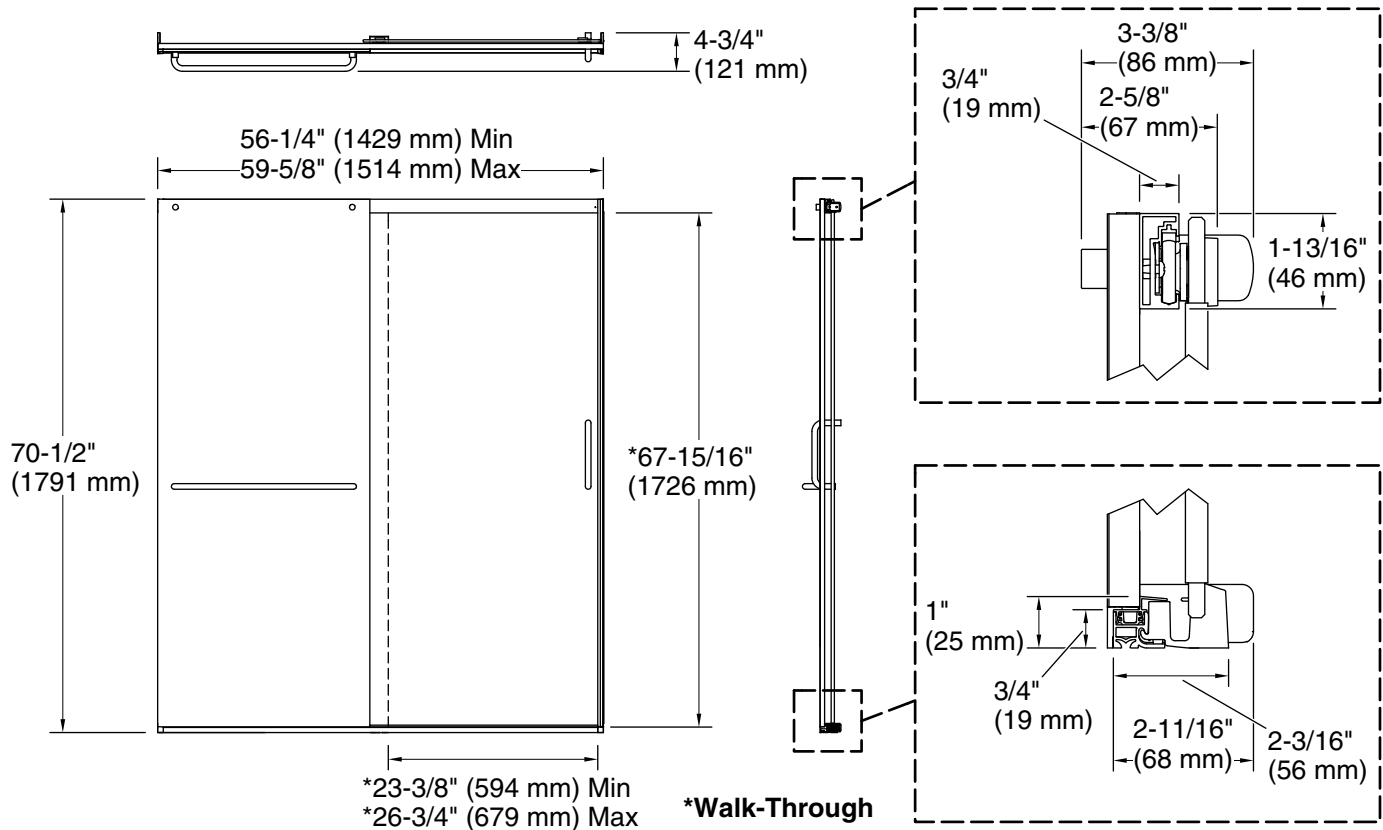

Technical Information

All product dimensions are nominal.

Installation type:	For shower base installation
Opening Width - Min:	56-1/4" (1429 mm)
Opening Width - Max:	59-5/8" (1514 mm)
Walk-through - Min:	23-3/8" (594 mm)
Walk-through - Max:	26-3/4" (679 mm)
Base-To-Wall Radius - Max:	1/2" (13 mm)
Glass thickness:	1/4" (6 mm)
Glass coating:	CleanCoat®

Notes

Install this product according to the installation instructions.

The vertical opening should be a minimum of 73-13/16" (1875 mm) to allow for installation clearance.