

DETAIL A
SCALE 1:2

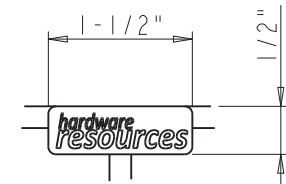
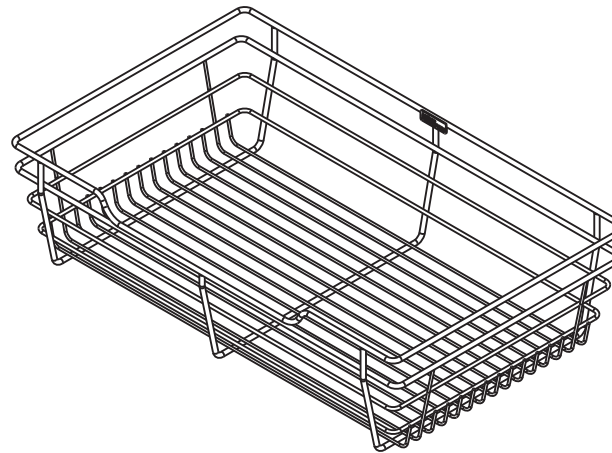
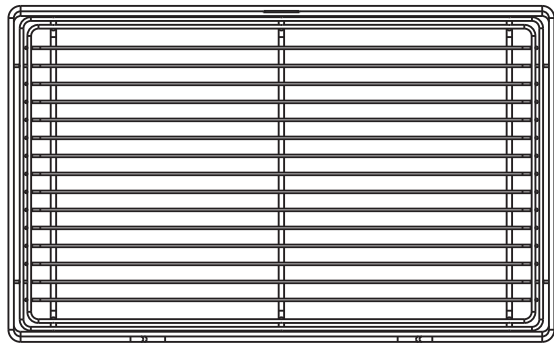

DETAIL B
SCALE 1:2

	ITEM:	POB1-14236CH		MATERIAL:	STEEL
	FINISH:			WEIGHT:	1855.90 g
PROPRIETARY AND CONFIDENTIAL THE INFORMATION CONTAINED IN THIS DRAWING IS THE SOLE PROPERTY OF HARDWARE RESOURCES INC. ANY REPRODUCTION IN PART OR AS A WHOLE WITHOUT THE WRITTEN PERMISSION OF HARDWARE RESOURCES INC. IS PROHIBITED.	TOLERANCE UNLESS OTHERWISE SPECIFIED: X ±0.20 XX ±0.10 XXX ±0.05 ANGULAR: ±0.5°		UNITS: IN SIZE: A4 SHEET: 1 OF 1	DRAWN BY: APPROVED BY: RELEASE LEVEL: 	DATE: 03-23-15 DATE: REVISION:
	DO NOT SCALE DRAWING				
	PROJECTION				