

Contemporary Lighting

PRODUCT NAME: Nob

ITEM NUMBER: E20862-75GLDBK

Please consult your electrician for hanging fixture and wiring.

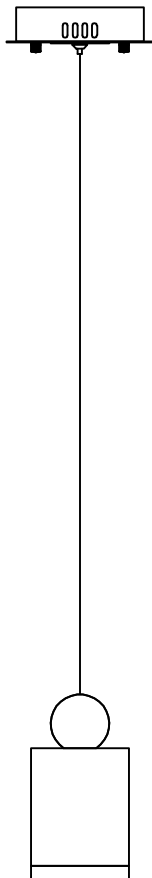

The fixture is designed to dim with a standard Triac forward phase dimmer. Dimming levels will vary by dimmer.

Below is a list of recommended dimmers:

Lutron MACL-153M

Lutron DVL-153P

Lutron SCL-153P

Leviton IPL06-10Z

Leviton 6674-POW

Due to inrush current wattage should not exceed 150 watts of product for a 600 watt dimmer.

Warning! Wires need to be connected to driver found in canopy and should not be connected directly to power source or a short may occur.

Bulb(integrated):LED 7.2W

IMPORTANT: Turn off the power at the main fuse or circuit breaker box before starting installation



(A)
Mounting Bracket



(C)
Finial

Locate all hardware & components before discarding packaging

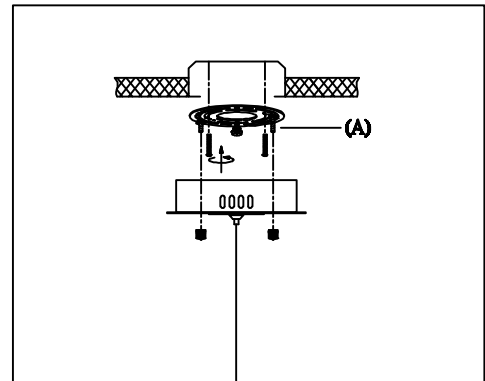
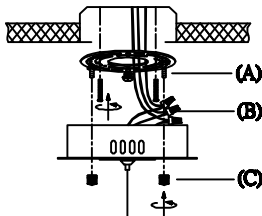

1.)

Step.1: Remove mounting bracket (A) from fixture and install to electrical box.

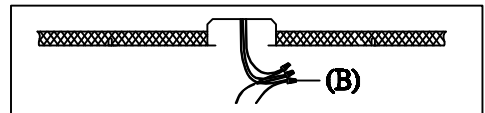

2.)

Step.2: Wire fixture to wires (B) in outlet box. Copper wire is for Ground.

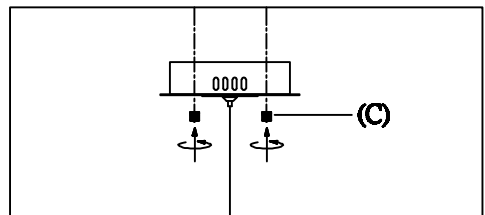

3.)

Step.3: Adjust wire length to desired mounting height, and tighten strain relief screws to secure. Install fixture to bracket and tighten finials (C) at the ends of the canopy to secure.

Cleaning & Care:

Clean with soft cloth and a mild detergent.
Do not use abrasive cleaner.