

PRODUCT SPECIFICATIONS

Elkay Crosstown® Stainless Steel 33" x 22" x 9", Single Bowl Dual Mount Sink Kit. Sink is manufactured from 18 gauge 304 Stainless Steel with a Polished Satin finish, Rear Center drain placement, and Sound Guard.

Installation Type:	Drop-in, Undermount
Material:	304 Stainless Steel
Special Features:	Slim Rim
Finish:	Polished Satin
Gauge:	18
Sound Deadening:	Sound Guard
Number of Bowls:	1
Sink Dimensions:	33" x 22" x 9"
Bowl 1 Dimensions:	30-1/2" x 16-3/4" x 9"
Drain Size:	3-1/2" (89mm)
Drain Location:	Rear Center
Minimum Cabinet Size:	36"
Template Included:	Yes
Cutout Template #:	1000001180

Template is available for download at [elkay.com](#)

Cutout Dimensions for Top Mount Installation:

32-3/8" x 21-3/8" (822mm x 543mm) with 1/2" (12mm) corner radius

Hole Drilling Configurations:

1-1/2" (38mm) Diameter Faucet Holes on 4" (102mm) Centers

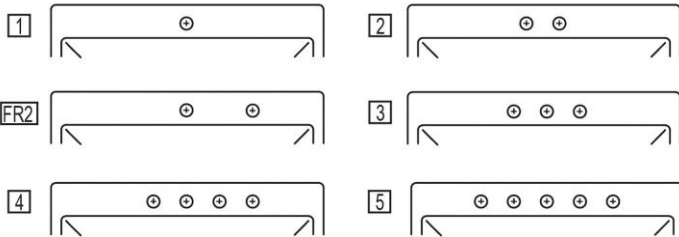

Included with Product: ECTSR33229T Sink, CTXBG2915 Bottom Grid

AMERICAN PRIDE. A LIFETIME TRADITION.

Like your family, the Elkay family has values and traditions that endure. For almost a century, Elkay has been a family-owned and operated company, providing thousands of jobs that support our families and communities.

Product Compliance: ASME A112.19.3/CSA B45.4



Sinks are listed by IAPMO® as meeting the applicable requirements of the Uniform Plumbing Code®, International Plumbing Code®, and National Plumbing Code of Canada.

[Clean and Care Manual \(PDF\)](#)
[Installation Instructions \(PDF\)](#)
[Limited Lifetime Warranty \(PDF\)](#)

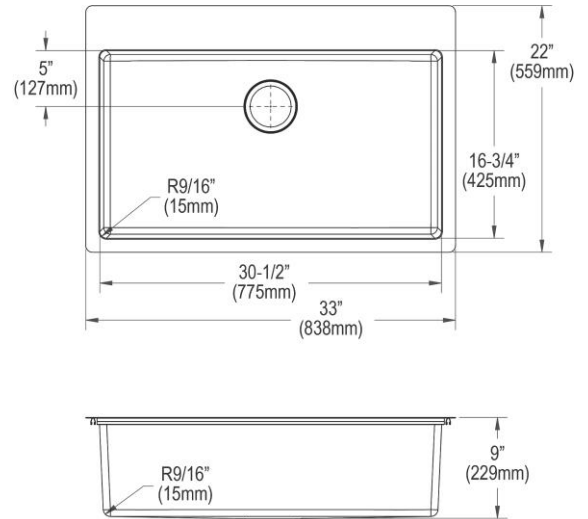

PART: _____ QTY: _____

PROJECT: _____

CONTACT: _____

DATE: _____

NOTES: _____

APPROVAL: _____

In keeping with our policy of continuing product improvement, Elkay reserves the right to change product specifications without notice. Please visit [elkay.com](#) for the most current version of Elkay product specification sheets. This specification describes an Elkay product with design, quality, and functional benefits to the user. When making a comparison of other producers' offerings, be certain these features are not overlooked.

Installation Profile:

DROP-IN

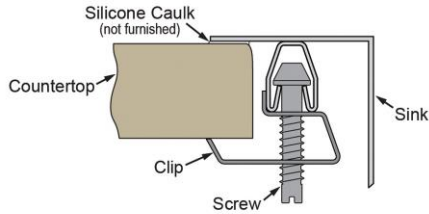

UNDERMOUNT - 1/8" OVERHANG

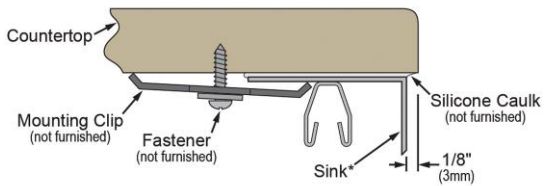

*Designed to affix to the underside of any solid surface countertop.

OPTIONAL ACCESSORIES

Drain:	LKDD, LK35
Hardware:	LKUCLIP8
Sinkmate:	LKSMHSL

In keeping with our policy of continuing product improvement, Elkay reserves the right to change product specifications without notice. Please visit elkay.com for the most current version of Elkay product specification sheets. This specification describes an Elkay product with design, quality, and functional benefits to the user. When making a comparison of other producers' offerings, be certain these features are not overlooked.