

# Assembly Instruction Sheet #IS-9735W24 For Style 9735W24



**Tools Required:** Flathead screwdriver, Phillips screwdriver, pliers, wire cutters, wire strippers, electrical tape, safety glasses.

**Light Source:** (3) E26 base tubular incandescent (not included).  
**Estimated Assembly Time:** 15-30 minutes.  
**Preparation:** Identify and inspect all parts before beginning installation. Check package content list and diagrams before to be sure all parts are present. If any parts are missing or damaged, do not attempt to assemble, install, or operate the fixture. Contact customer service for replacement parts.

### ⚠ Warnings and Cautions

Turn off electricity at circuit breaker or main fuse box before installation. Consult a licensed electrician if in doubt. These instructions are provided for your safety. It is very important you read them completely before installing the fixture. We strongly recommend that a licensed, professional electrician perform the installation. Disconnect fixture from power source before replacing bulbs. Make sure bulbs are given sufficient time to cool before removal.

### Package Contents

-  **A** Ceiling Canopy x1
-  **B** Glass x3

-  **C** Ring x3
-  **D** Arm x3

PART	DESCRIPTION	QUANTITY
AA	Connection	2pcs
BB	Wire nut	2pcs
CC	Outlet Box Screw	2pcs

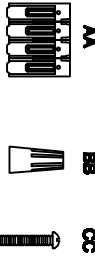

### STEP 1 - Release Mounting Bracket from Ceiling Canopy.

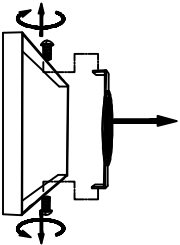

Figure 1

### STEP 2 - Install Arm to Ceiling Canopy

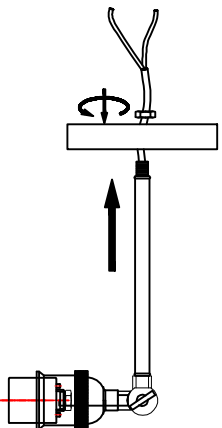

Figure 2

### STEP 3 - Wire Connections

A. The positive pole connects the positive pole and the negative pole connects the negative pole

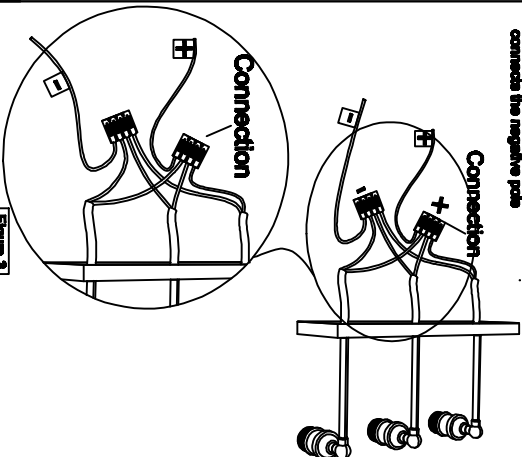

Figure 3

### STEP 5 - Wire Connections

A. Use standard wire connectors to make all wire connections. Twist connectors until wires are tightly joined together. Wrap each connection with approved electrical tape and carefully stuff all the connected wires into the Outlet Box.

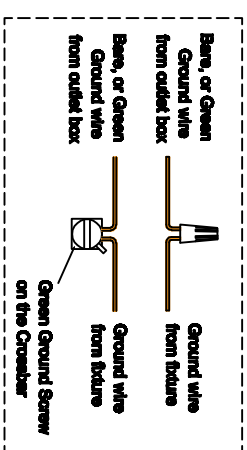
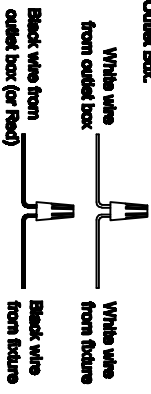

Figure 5

STEP 4 - Attach Mounting Bracket to Outlet Box  
 A. Pass the supply wires through the Mounting bracket (EE). Attach the mounting bracket (EE) to the Outlet Box with the head of the Green Ground Screw (CC) sending you. Secure it with Outlet Box Screws. Tighten until snug.

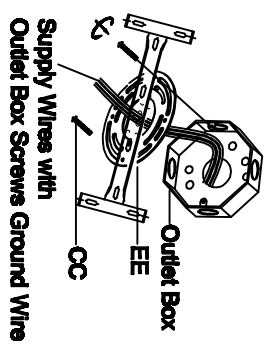

Figure 4

### STEP 6 - Install Glass to Fixture Body.

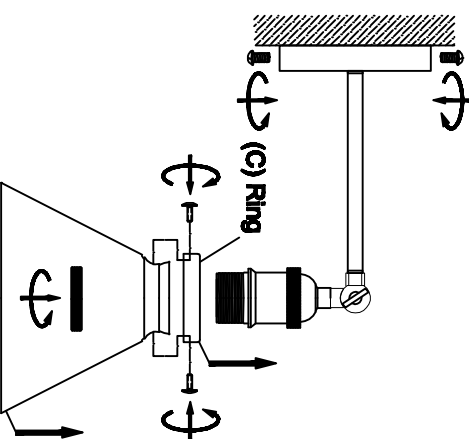

Figure 6