

Trade Mark:
CRYSTAL WORLD INC

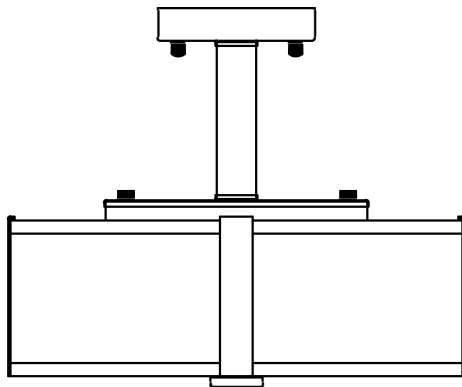

Product Name: Pendant lamp
Model :5571P14C-R
120Vac, 60Hz,AC ONLY
Lamp size:D14"*H12"



CEILING LAMP ASSEMBLY INSTRUCTIONS

1. Place fixture(A) onto mounting screws (DD).secure with cap nuts (AA).
Place fix (A) and (B) with (C),(D) and (E)with(C).

Hardware Used

AA Cap nut		X 2
DD Mounting screw		X 2

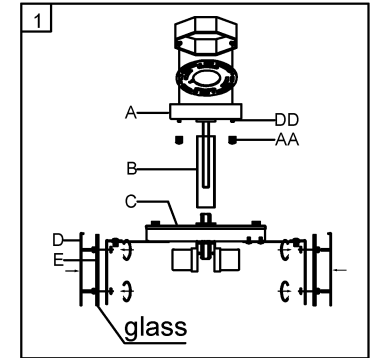

2. Install light bulbs (not included).
Use bulb
120V E26  **3*60W Max.**

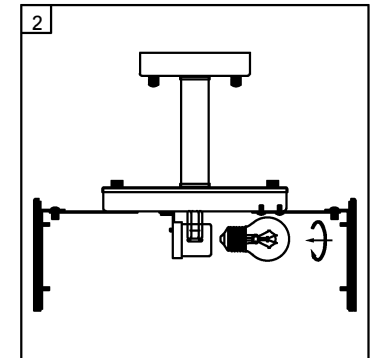

3. Place fix (F) and (G) with (C).

