

Trade Mark:  
CRYSTAL WORLD INC

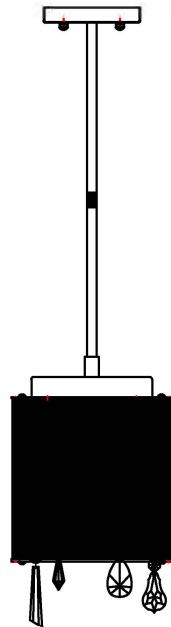

Product Name: Ceiling lamp  
Model :5562P8C  
120Vac, 60Hz,AC ONLY  
Lamp size:Ø8"xH9"



## PENDANT LAMP ASSEMBLY INSTRUCTIONS

1. Please fix (A) with (B).  
Place fixture (A) onto mounting screws (DD). secure with cap nuts (AA).

### Hardware Used

AA Cap nut		X 2
DD Mounting screw		X 2

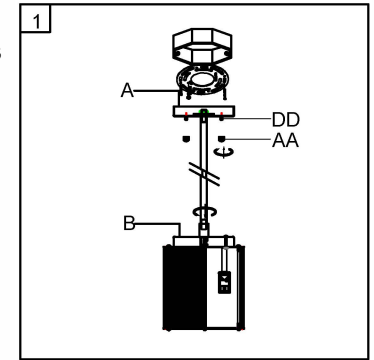

2. Please wear gloves when you hanging the crystal.

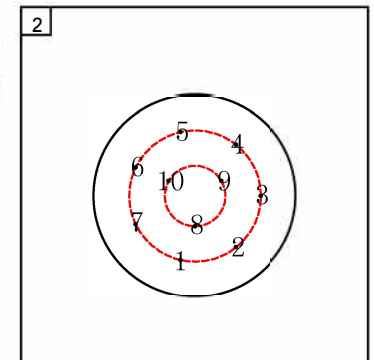
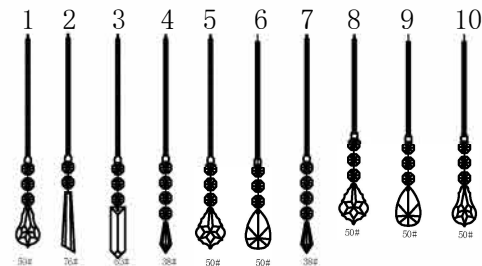

3. Install light bulbs (not included).  
Use bulb  
120V G9  2\*40W Max.

