

Trade Mark:  
CRYSTAL WORLD INC

Product Name: Pendant lamp  
Model :5535P16C-RB  
120Vac, 60Hz, AC ONLY  
Lamp Size:L16"\*W16"\*H59"

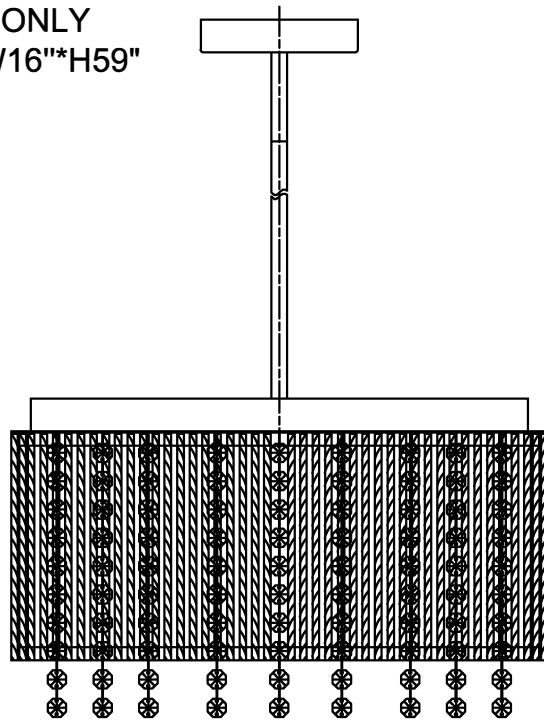

## PENDANT LAMP ASSEMBLY INSTRUCTIONS

1. Place fixture(A) onto mounting screws (DD). secure with cap nuts (AA). Please fix (A) with (B). (B) with (C), (C) with (D).

### Hardware Used

AA Cap nut  X 2  
DD Mounting screw  X 2

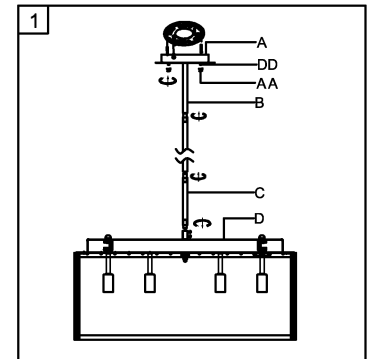

2. Please hang the crystal (1) (2) to the fixture .

1 14mm\*10PCS 132PCS  
2 14mm\*9PCS 1PCS

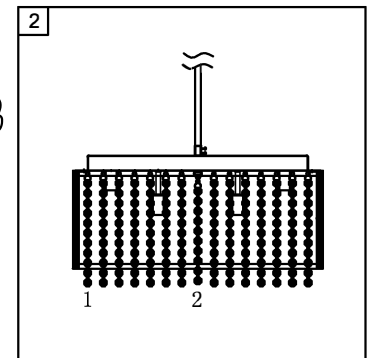

3. Install light bulbs ( not included).  
Use bulb  8\*40W Max.

