

Trade Mark:  
CRYSTAL WORLD INC

Product Name: Pendant lamp  
Model :5443P14C  
120Vac, 60Hz,AC ONLY  
Lamp Size:Ø14"X48"H

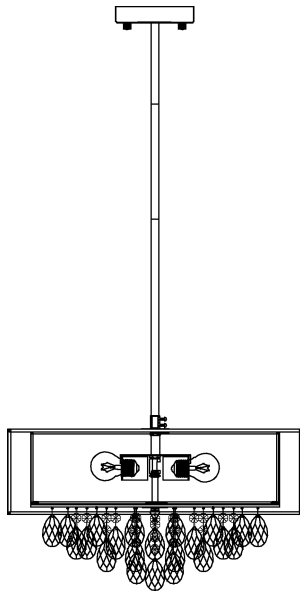



## PENDANT LAMP ASSEMBLY INSTRUCTIONS

1. Place fixture(A) onto mounting screws (DD), secure with cap nuts (AA). Please fix (A) with (B). (B) with (C), (C) with (D).

### Hardware Used

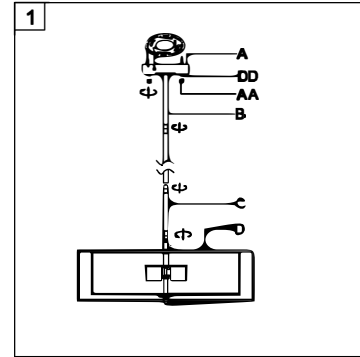



AA Cap nut  X 2  
DD Mounting screw  X2

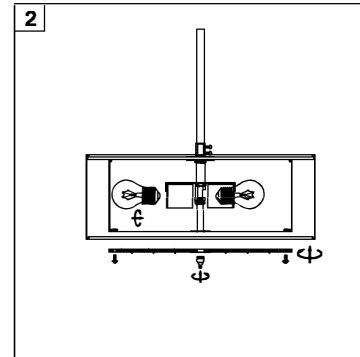

2. Light bulbs (not included).  
**120V E26**  **3\*60W Max.**



3. Please hang the crystal (1) (2) (3) (4) to the fixture.

1  50mm\*1PCS 12PCS  
2  14mm\*1PCS 8PCS  
3  14mm\*2PCS 5PCS  
4  50mm\*1PCS

