

Trade Mark:
CRYSTAL WORLD INC

Product Name: Pendant lamp
Model :5077P16C-RC
120Vac, 60Hz,AC ONLY
Lamp Size:L16**W5**H6"-H48"

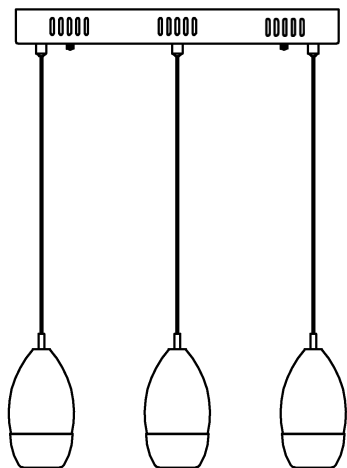

PENDANT LAMP ASSEMBLY INSTRUCTIONS

1. Place fixture(A) onto mounting screws (DD), secure with cap nuts (AA).

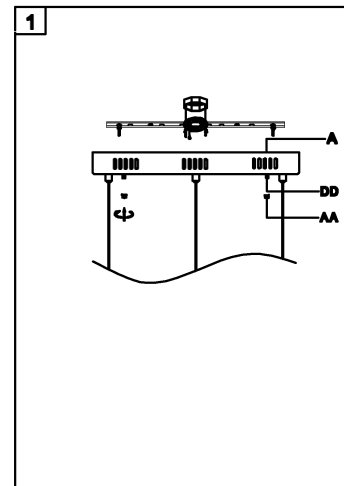

Hardware Used

AA Cap nut  X 2

DD Mounting screw  X 2

2. Install light bulbs (not included).

Use bulb

12V G4  3*20W Max.

