

Assembly Instruction Sheet #IS-1245P40 For Style 1245P40











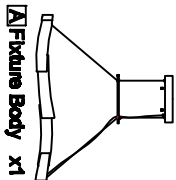

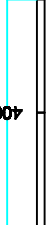
Tools Required: Flathead screwdriver, Phillips screwdriver, pliers, wire cutters, wire strippers, electrical tape, safety glasses.
Light Source: LED • (W/ DIMMABLE) (3000K)
Estimated Assembly Time: 10-20 minutes

Preparation: Identify and inspect all parts before beginning installation. Check package content list and diagrams below to be sure all parts are present. If any parts are missing or damaged, do not attempt to assemble, install, or operate the fixture. Contact customer service for replacement parts.

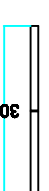
⚠ Warnings and Cautions

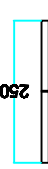
Turn off electricity at circuit breaker or main fuse box before installation. Consult a licensed electrician if in doubt. These instructions are provided for your safety. It is very important you read them completely before installing the fixture. We strongly recommend that a licensed, professional electrician perform the installation. Disconnect fixture from power source before replacing bulbs. Make sure bulbs are given sufficient time to cool before removal.

Package Contents

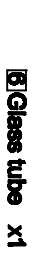
-  Fixture Body x1
-  Glass tube x5
-  Aluminum tube x1
-  Glass tube x6
-  Aluminum tube x2
-  Glass tube x5
-  Aluminum tube x2
-  Glass tube x4
-  Aluminum tube x2
-  Glass tube x4
-  Aluminum tube x4
-  Glass tube x4
-  Aluminum tube x1
-  Glass tube x1

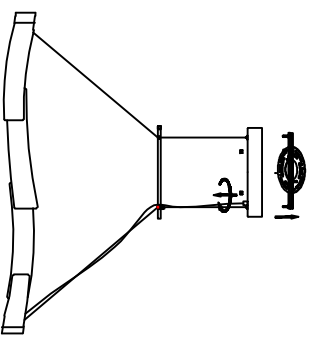

Figure 1

STEP 1 - Release Crossbar from Ceiling Canopy.

STEP 2 - Attach Crossbar to Outlet Box.
A. Pass the supply wires through the Crossbar (EE).
Attach the Crossbar (EE) to the Outlet Box (OC) with the head of the Green Ground Screw facing you. Secure it with Outlet Box Screws (not included). Tighten until snug.

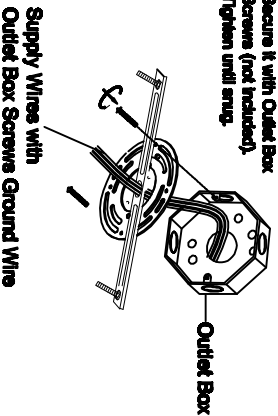

Figure 2

STEP 3 - Wire Connections
A. Use standard wire connectors (not included) to make all wire connections. Twist connectors until wires are tightly joined together. Wrap each connection with approved electrical tape and carefully stuff all the connected wires into the Outlet Box.

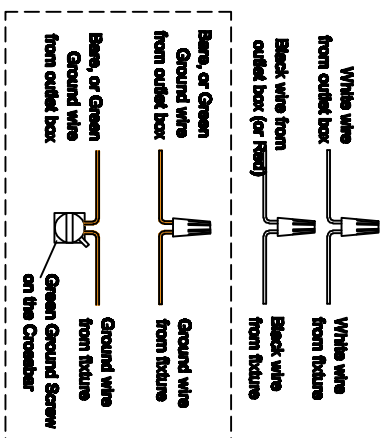

Figure 3

STEP 4 - Install Ceiling Canopy to Ceiling

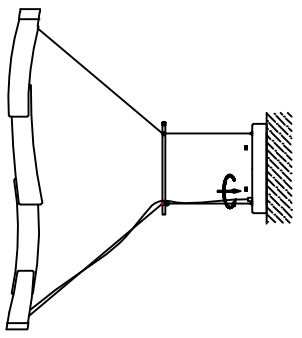

Figure 4

STEP 6 - Install Crystal

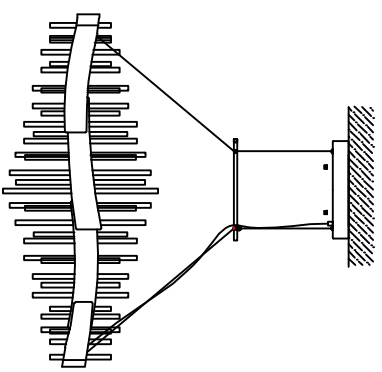
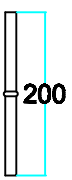
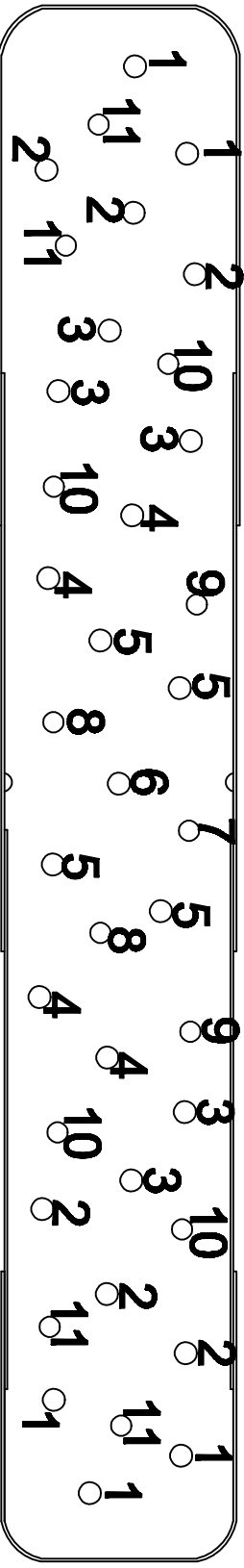
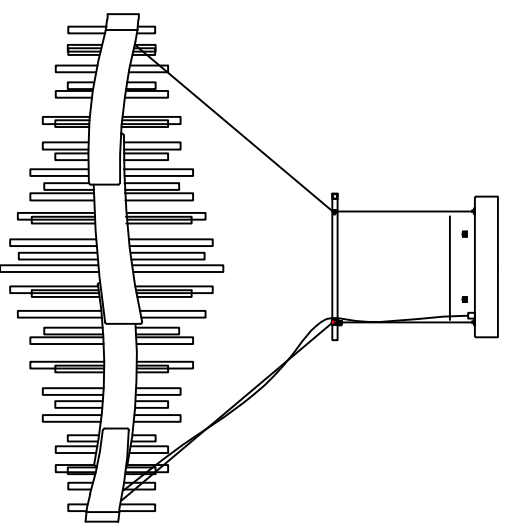

Figure 5



1 Glass tube x5



4 Glass tube x4

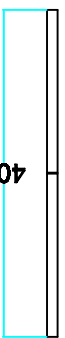

7 Aluminium tube x1

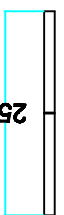

10 Aluminium tube x4



2 Glass tube x6

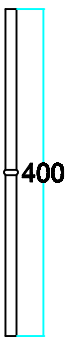

5 Glass tube x4

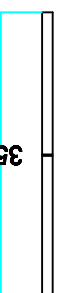

8 Aluminium tube x2

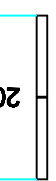

11 Aluminium tube x4

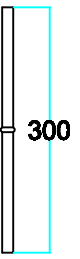

3 Glass tube x5

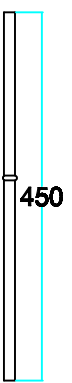

6 Glass tube x1

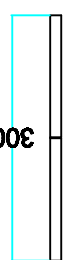

9 Aluminium tube x2