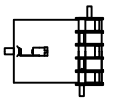
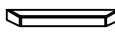






# Assembly Instruction Sheet #S-1065W8 For Style 1065W8

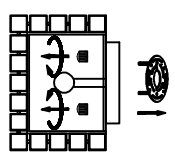
**Tools Required:** Flathead screwdriver, Phillips screwdriver, pliers, wire cutters, wire strippers, electrical tape, safety glasses.  
**Light Source:** (1) E12 Candeflex Base Bulb (6W Maximum/Volc Industry).  
**Estimated Assembly Time:** 15-30 minutes.  
**Preparation:** Identify and inspect all parts before beginning installation. Check package content list and determine labor to be sure all parts are present. If any parts are missing or damaged, do not attempt to assemble, install, or operate the fixture. Contact customer service for replacement parts.

**⚠ Warnings and Cautions**  
 Turn off electricity at circuit breaker or main fuse box before installation. Consult a licensed electrician if in doubt. These instructions are provided for your safety. It is very important you read them completely before installing the fixture. We strongly recommend that a licensed, professional electrician perform the installation. Disconnect fixture from power source before replacing bulbs. Make sure bulbs are given sufficient time to cool before removal.

## Package Contents

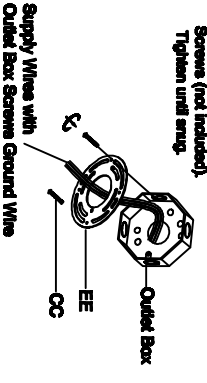
	1 Fixture Body x1 (There are no holes on the left and right sides)
	1 Crystal Rods x13 (There are no holes on the left and right sides)
	1 Boboche x1
	2 Crystal Rods x1 (There are holes on the left)
	1 Socket sleeve x1
	1 Allen Key x1 3 Crystal Rods x1 (There are holes on the right)

**STEP 1 - Release Mounting Bracket from Ceiling Canopy.**



**Figure 1**

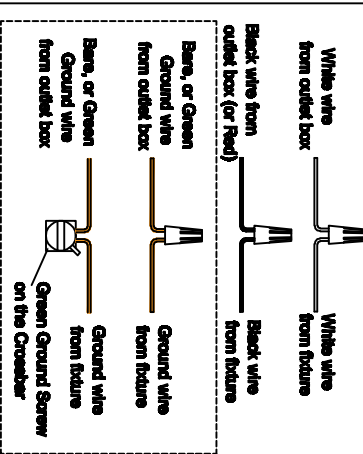
**STEP 2 - Attach Mounting Bracket to Outlet Box**  
 A. Pass the supply wires through the Crocker (EE).  
 Attach the Crocker (EE) to the Outlet Box (CC) with the head of the Green Ground Screw facing you. Secure it with Outlet Box Screws (not included). Tighten until snug.



**Figure 2**

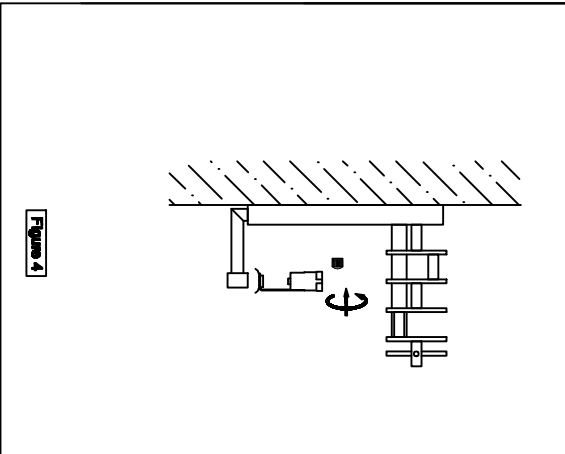
Supply Wires with Outlet Box Screws Ground Wire

**STEP 3 - Wire Connections**  
 A. Use standard wire connectors to make all wire connections. Twist connections until wires are tightly joined together. Wrap each connection with approved electrical tape and carefully stuff all the connected wires into the Outlet Box.

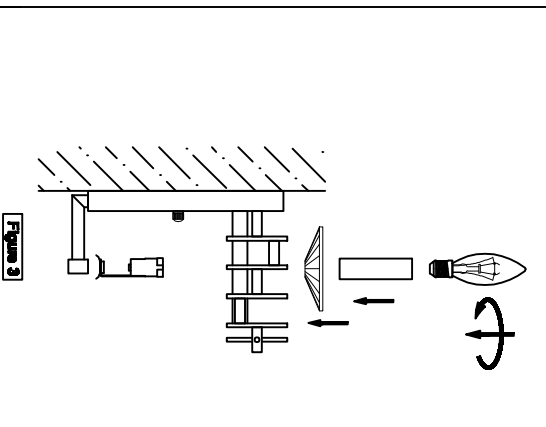


**Figure 3**

**STEP 4 - Install Backplate to Ceiling**



**STEP 5 - Install Bulbs, Socket sleeve and Bulb.**



**STEP 6 - Install Bulbs.**

