

Stainless Steel Kitchen Sink

Top-Mount Double Bowl

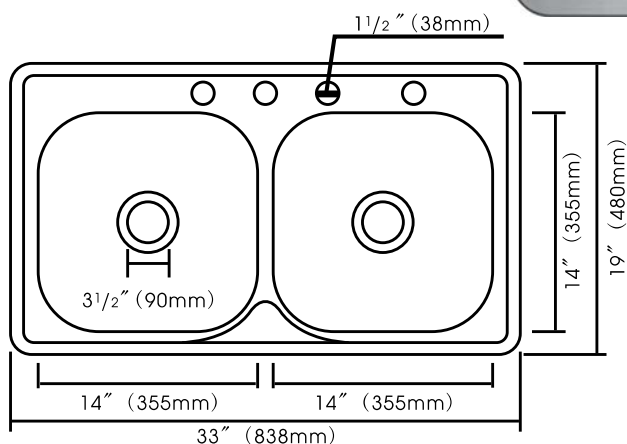

Model	Depth	Gauge	Hole
004-632	6"	23G	4
006-052	7"	22G	4
006-780	8"	22G	4

33" x 19" Top-Mount 50/50 Double Bowl

FEATURES

- * Premium Grade 304 Stainless Steel
- * 6" Depth * 23 Gauge
- * 7" Depth * 22 Gauge
- * 8" Depth * 22 Gauge
- * Lustrous Satin
- * 3 1/2" Drain Opening
- * Fully Coated Underneath with Heavy Duty Sound Deadening Pads
- * Supplied with Fasteners and Instructions
- * Cutout Template on Box
- * Limited Lifetime Warranty

Project / Job Name			
Architect / Engineer			
Contractor			
Model		Qty	
Notes :			

Optional Accessories



Basket Strainers



Deep Cup Basket Strainers



Garbage Disposal Flange & Stopper



Soap Dispensers